

POWERTWIST PLUS V-BELTS

(How to Measure, Assemble and Install)

I. HOW TO MEASURE

Pull belt tight around sheaves to check hand tight length, overlapping the last two tabs with two holes in matching links as shown. Count the number of links and remove one link for every 24 of O/3L, A/4L and B/5L Sections, and one link for every 20 of C Section. This gives the correct installed belt length and will ensure optimum belt tension when running. Note: Every tenth link is designated with an arrow. For multiple belt drives, ensure that each belt has the same number of links.

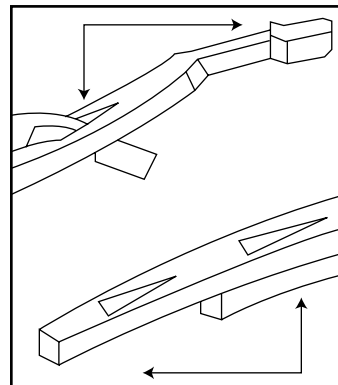

II. DISASSEMBLY

- Hold belt upside down. Bend back as far as possible; hold with one hand. Twist one tab 90° parallel with slot.
- Pull end of link over tab.
- Rotate belt end with tab 90°.
- Pull belt end through two links.

III. ASSEMBLY

- Hold belt with tabs pointing outward.
- Place end tab through two links at once.
- Flex belt further and insert second tab through end link by twisting tab with thumb.
- Ensure tab returns to position across belt. Reverse belt so tabs run inside.

Important: Turn belt INSIDE OUT (as shown) to ensure easy assembly and disassembly.

IV. INSTALLATION

- Turn belt with tabs to the inside before installing.
- Determine direction of drive rotation.
- Align belt directional arrow with drive rotation.
- Fit belt in nearest groove of smaller sheave.
- Roll belt onto larger sheave, turning the drive slowly. Belt may seem very tight; this is okay; **DO NOT JOG MOTOR.**
- Check to see all tabs are still in their correct position and are not twisted out of alignment.
- For multiple belt drives, work belt from groove to groove. On particularly wide drives, it may be easier to install half the belts from the inboard side and half from the outboard. **Note:** With drive ratios around 1:1, it may be necessary to add back one link to allow belts to be rolled on. This does not apply if using Alternative Installation Method.

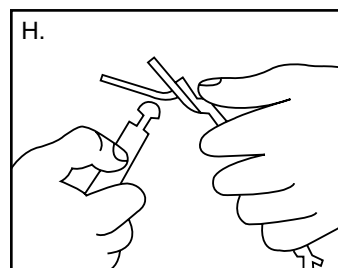
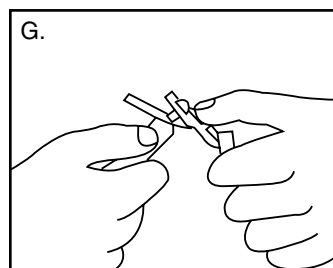
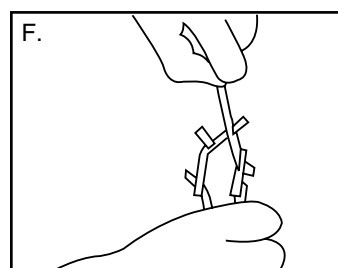
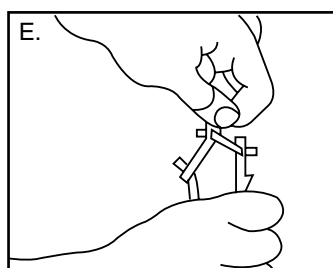
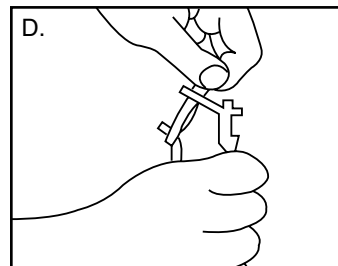
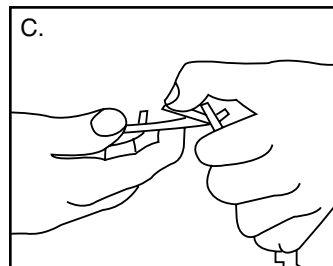
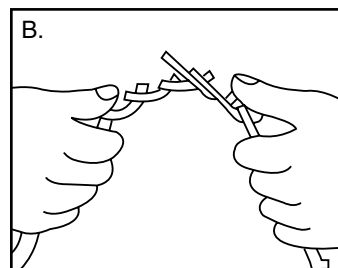
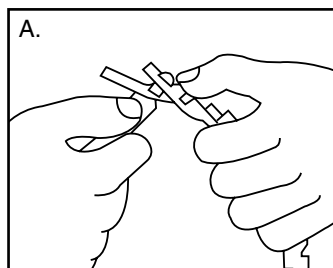

V. ALTERNATIVE INSTALLATION METHOD

- Set motor to mid position of adjustment range and mark base clearly.
- Determine required belt length as in I.
- Push motor forward to minimum center distance.
- Install belts as in IV.
- Pull motor back to previously marked mid position.

VI. RE-TENSIONING

Like all high performance V-belts, PowerTwist Plus V-belts require maintenance for correct drive tension to operate efficiently. Experience indicates that drive tension should be checked after 24 hours of running at full load. A re-tension may be necessary depending on the severity of the drive. Any initial belt stretch is then taken up. Subsequently, belt tension should be checked periodically and adjusted when necessary.