

Model W1676 COMBINATION SANDER MANUAL UPDATE

This update covers changes made to the machine after the owner's manual was printed. All page number references refer to the owner's manual for this machine. Keep this update with your owner's manual for future reference. *If you have questions, contact Tech Support at (360) 734-3482 or by email at tech_support@shopfox.biz.*

What Changed?

We added a sleeve guard to the sander to help reduce the risk of entanglement. The sleeve guard **MUST** be installed on the idler roller guard, using the included lock knobs and flat washers, as shown in **Figure 1**.

Install the idler roller guard and sleeve guard onto the idler roller after belt tension and tracking are properly set, as described in the Model W1676 Manual on **Pages 18 & 19**.

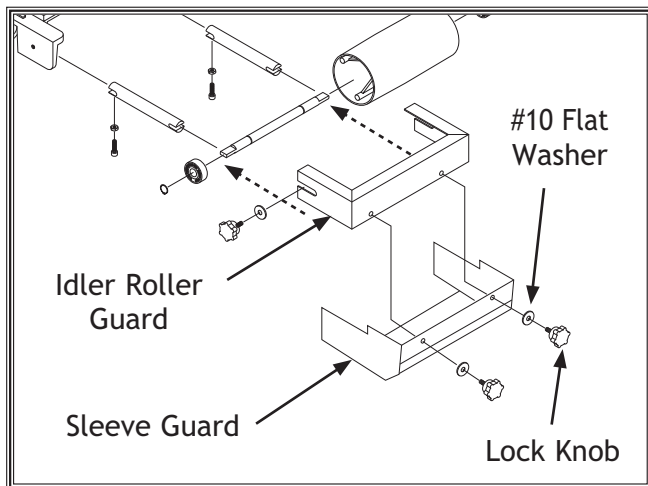

Figure 1. Installing sleeve guard.

Machine Inventory (See Page 11)

The following items have been added. Refer to the full manual for a description of all other inventory components.

| | |
|---------------------------|------------|
| Box Contents: | Qty |
| A. Sleeve Guard | 1 |
| B. Lock Knobs | 2 |
| C. Flat Washers #10 | 2 |

New Sleeve Guard Parts

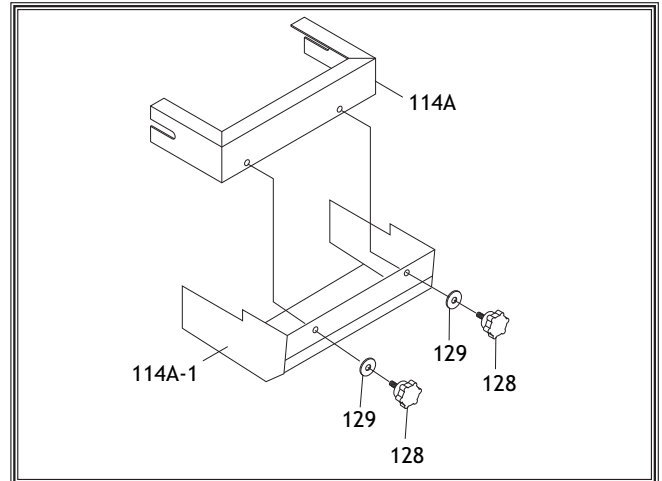

Figure 2. New sleeve guard parts.

| REF | PART # | DESCRIPTION |
|--------|-------------|-----------------------------|
| 114A | X1676114A | IDLER ROLLER GUARD V2.03.08 |
| 114A-1 | X1676114A-1 | SLEEVE GUARD |
| 128 | X1676128 | LOCK KNOB |
| 129 | PW03 | FLAT WASHER #10 |

COPYRIGHT © MARCH, 2008 BY WOODSTOCK INTERNATIONAL, INC.

WARNING: NO PORTION OF THIS MANUAL MAY BE REPRODUCED IN ANY SHAPE OR FORM WITHOUT

THE WRITTEN APPROVAL OF WOODSTOCK INTERNATIONAL, INC.

#10609BL

Printed in Taiwan

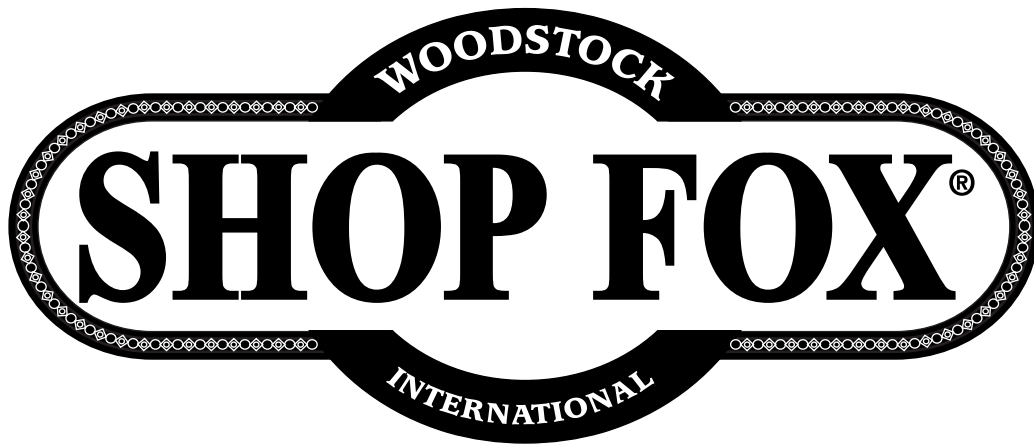

MODEL W1676 COMBINATION SANDER



INSTRUCTION MANUAL

Phone: 1-360-734-3482 • On-Line Technical Support: tech-support@woodstockint.com

COPYRIGHT © 2001 BY WOODSTOCK INTERNATIONAL, INC.
WARNING: NO PORTION OF THIS MANUAL MAY BE REPRODUCED IN ANY SHAPE OR FORM WITHOUT
THE WRITTEN APPROVAL OF WOODSTOCK INTERNATIONAL, INC.

Printed in Taiwan

WARNING

Some dust created by power sanding, sawing, grinding, drilling, and other construction activities contains chemicals known to the State of California to cause cancer, birth defects or other reproductive harm. Some examples of these chemicals are:

- Lead from lead-based paints.
- Crystalline silica from bricks, cement, and other masonry products.
- Arsenic and chromium from chemically treated lumber.

Your risk from these exposures varies, depending on how often you do this type of work. To reduce your exposure to these chemicals: work in a well ventilated area, and work with approved safety equipment, such as those dust masks that are specially designed to filter out microscopic particles.

Table Of Contents

| | PAGE |
|---------------------------------------|-------|
| 1. INTRODUCTION | 2 |
| ABOUT YOUR NEW SANDER..... | 2 |
| WOODSTOCK SERVICE AND SUPPORT | 2 |
| WARRANTY AND RETURNS | 3 |
| MACHINE SPECIFICATIONS | 3 |
| 2. SAFETY | 4 |
| SAFETY FIRST | 4-5 |
| SANDER SAFETY..... | 6 |
| 110V ELECTRICAL REQUIREMENTS | 7 |
| 220V ELECTRICAL REQUIREMENTS | 8 |
| AVOIDING POTENTIAL INJURIES | 9 |
| 3. ASSEMBLY INSTRUCTIONS | 10 |
| UNPACKING | 10-11 |
| CLEAN UP | 12 |
| GENERAL | 13 |
| SANDING UNIT TO BASE | 14 |
| IDLER ROLLER | 14 |
| SANDING DISC | 14 |
| BACK STOP | 15 |
| DUST PORTS | 15 |
| WORKING TABLE | 16 |
| QUICK RELEASE | 16 |
| 4. ADJUSTMENTS..... | 17 |
| GENERAL | 17 |
| BELT TRACKING/TENSION | 18-19 |
| IDLER GUARD | 19 |
| VERTICAL POSITIONING | 20 |
| CHANGING DISC ABRASIVE..... | 21 |
| TABLE TILT..... | 22 |
| 5. OPERATIONS | 23 |
| TESTING..... | 23 |
| HORIZONTAL SANDING | 24 |
| CURVED SANDING | 24 |
| DISC SANDING | 25 |
| 6. MAINTENANCE..... | 26 |
| GENERAL | 26 |
| TABLE AND BASE | 26 |
| LUBRICATION | 26 |
| 7. CLOSURE | 27 |
| 8. WIRING DIAGRAM | 28 |
| PARTS BREAKDOWN AND PARTS LISTS | 29-32 |

USE THE QUICK GUIDE PAGE LABELS TO SEARCH OUT INFORMATION FAST!





INTRODUCTION

ABOUT YOUR NEW SANDER

This new Shop Fox® W1676 Sander has been specially designed to provide many years of trouble-free service. Close attention to detail, ruggedly built parts and a rigid quality control program assure safe and reliable operation.

The Model W1676 is capable of a wide variety of sanding operations. The 6" wide belt can quickly sand large surfaces flat and the 10" sanding disc and adjustable table can sand many different angles. The combination sander comes with a cabinet-style stand, miter gauge, 1 H.P. motor, sanding belt and disc, and electrical package.

Woodstock International, Inc. is committed to customer satisfaction in providing this manual. It is our intent to make sure all the information necessary for safety, ease of assembly, practical use and durability of this product be included.

If you should have any comments regarding this manual, please feel free to contact us at:

Woodstock International, Inc.
Attn: Technical Department
P.O. Box 2309
Bellingham, WA 98227

WOODSTOCK SERVICE AND SUPPORT

We stand behind our machines! In the event that a defect is found, parts are missing or questions arise about your machine, please contact Woodstock International Service and Support at 1-360-734-3482 or send e-mail to: tech-support@woodstockint.com. Our knowledgeable staff will help you troubleshoot problems, send out parts or arrange warranty returns.

WARRANTY AND RETURNS

Woodstock International, Inc. warrants all SHOP FOX® machinery to be free of defects from workmanship and materials for a period of 2 years from the date of original purchase by the original owner. This warranty does not apply to defects due directly or indirectly to misuse, abuse, negligence or accidents, lack of maintenance, or to repairs or alterations made or specifically authorized by anyone other than Woodstock International, Inc.

Woodstock International, Inc. will repair or replace, at its expense and at its option, the SHOP FOX® machine or machine part which in normal use has proven to be defective, provided that the original owner returns the product prepaid to the SHOP FOX® factory service center or authorized repair facility designated by our Bellingham, WA office, with proof of their purchase of the product within 2 years, and provides Woodstock International, Inc. reasonable opportunity to verify the alleged defect through inspection. If it is determined there is no defect, or that the defect resulted from causes not within the scope of Woodstock International Inc.'s warranty, then the original owner must bear the cost of storing and returning the product.

This is Woodstock International, Inc.'s sole written warranty and any and all warranties that may be implied by law, including any merchantability or fitness, for any particular purpose, are hereby limited to the duration of this written warranty. We do not warrant that SHOP FOX® machinery complies with the provisions of any law or acts. In no event shall Woodstock International, Inc.'s liability under this warranty exceed the purchase price paid for the product, and any legal actions brought against Woodstock International, Inc. shall be tried in the State of Washington, County of Whatcom. We shall in no event be liable for death, injuries to persons or property or for incidental, contingent, special or consequential damages arising from the use of our products.

Every effort has been made to ensure that all SHOP FOX® machinery meets high quality and durability standards. We reserve the right to change specifications at any time because of our commitment to continuously improve the quality of our products.

Machine Specifications

| | |
|-----------------------|--|
| Motor Size: | 1 H.P., 110/220V Single-Phase |
| Motor Speed | 3450 R.P.M. |
| Amps | 14/7 |
| Sanding Belt..... | 6" x 48" |
| Belt Speed | 1900 F.P.M. |
| Sanding Disc | 10" |
| Disc Speed | 2420 R.P.M. |
| Table (Disc) | 6" x 12 ¹ / ₄ " |
| Stand | Cabinet Style, Powder Coated Paint |
| Power Transfer | Belt Drive (3L-240) |
| Bearings | Shielded & Lubricated Ball Bearings |
| Switch | Paddle ON/OFF Switch, w/ Safety Lock Key |
| Shipping Weight | 170 lbs. |

SAFETY FIRST!

**READ MANUAL BEFORE OPERATING MACHINE.
FAILURE TO FOLLOW INSTRUCTIONS BELOW WILL
RESULT IN PERSONAL INJURY.**



Indicates an imminently hazardous situation which, if not avoided, **WILL** result in death or serious injury.



Indicates a potentially hazardous situation which, if not avoided, **COULD** result in death or serious injury.



Indicates a potentially hazardous situation which, if not avoided, **MAY** result in minor or moderate injury. It may also be used to alert against unsafe practices.

NOTICE

This symbol is used to alert the user to useful information about proper operation of the equipment.

1. **Thoroughly read the instruction manual before operating your machine.** Learn the applications, limitations and potential hazards of this machine. Keep manual in a safe, convenient place for future reference.
2. **Keep work area clean and well lighted.** Clutter and inadequate lighting invite potential hazards.
3. **Ground all tools.** If a machine is equipped with a three-prong plug, it must be plugged into a three-hole grounded electrical outlet or grounded extension cord. If using an adapter to aid in accommodating a two-hole receptacle, ground using a screw to a known ground.
4. **Wear eye protection at all times.** Use safety glasses with side shields or safety goggles that meet the national safety standards, while operating this machine.
5. **Avoid dangerous environments.** Do not operate this machine in wet or open flame environments. Airborne dust particles could cause an explosion and severe fire hazard.
6. **Ensure all guards are securely in place and in working condition.**
7. **Make sure switch is in the "OFF" position** before connecting power to machine.
8. **Keep work area clean, free of clutter, grease, etc.**
9. **Keep children and visitors away.** Visitors should be kept a safe distance away while operating unit.
10. **Childproof workshop** with padlocks, master switches or by removing starter keys.
11. **Disconnect machine when cleaning, adjusting or servicing.**

12. **Do not force tool.** The machine will do a safer and better job at the rate for which it was designed.
13. **Use correct tool.** Do not force machine or attachment to do a job for which it was not designed.
14. **Wear proper apparel.** Do not wear loose clothing, neck ties, gloves, jewelry, keep long hair tied up, etc.
15. **Remove adjusting keys and wrenches.** Before turning the machine on, make it a habit to check that all adjusting keys and wrenches have been removed.
16. **Use proper extension cord.** When using an extension cord, make sure it is less than 100' in length and that it is in good condition. Use extension cords that are rated Hard Service (grade 5) or better, and that have a conductor size of 16 A.W.G. A drop in line voltage, loss of power and overheating can result when using an undersized cord. The extension cord should have a ground wire and ground plug pin, as well.
17. **Keep proper footing and balance** at all times.
18. **Do not leave machine unattended.** Wait until it comes to a complete stop before leaving the area.
19. **Perform machine maintenance and care.** Follow lubrication and accessory attachment instructions in the manual.
20. **Keep machine away from open flame.** Operating machines near pilot lights and/or open flames creates a high risk if dust is dispersed in the area. Dust particles and an ignition source may cause an explosion. Do not operate the machine in high-risk areas, including but not limited to, those mentioned above.
21. **If at any time you are experiencing** difficulties performing the intended operation, stop using the machine! Then contact our service department or ask a qualified expert how the operation should be performed.
22. **Habits—good and bad—are hard to break.** Develop good habits in your shop and safety will become second-nature to you.

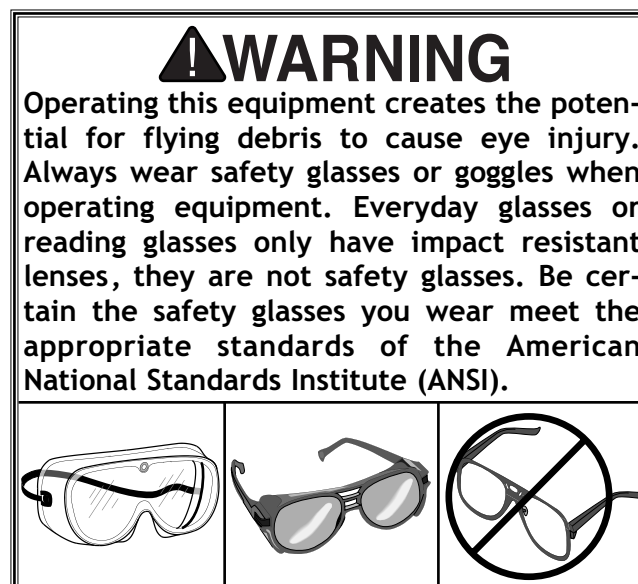

Additional Safety Instructions For Sanders

1. **Be aware of belt or disc rotation when sanding.** Always brace workpiece against the rotation of the sanding belt. Always sand on the side of the disc that is rotating downward, towards the work table.
2. **Keep fingertips away from the moving belt or disc.**
3. **Never use excessive force when sanding.** Doing this greatly increases the chances of personal injury and motor overload.
4. **Always feed the work against the direction of rotation.**
5. **Even if you have a reliable method of dust collection,** use a dust mask or respirator when sanding, as well as eye and ear protection.
6. **If there is any doubt as to the stability or integrity of the material to be sanded,** do not sand it.
7. **Do not operate sander with a damaged or badly worn disc or belt.**
8. **Habits – good or bad – are hard to break.** Develop good habits and safety will become second nature to you.
9. **Sanding dust from some woods may be toxic or cause an allergic reaction.** Be sure to wear an appropriate respirator when working around saw dust. Make sure there is adequate ventilation or a constant source of fresh air. The saw dust from some species of wood can be toxic to some people. Be sure to research the dangers of the specific species of wood you are working with.

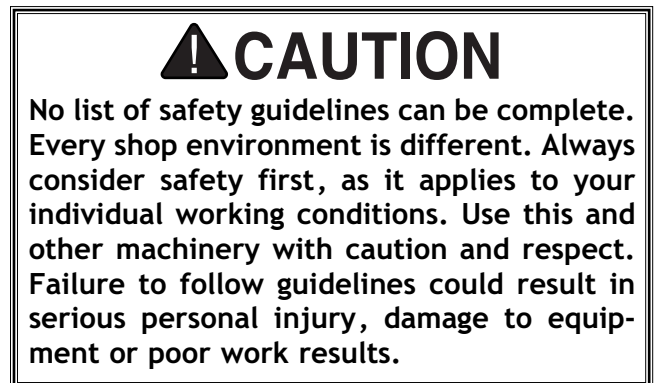
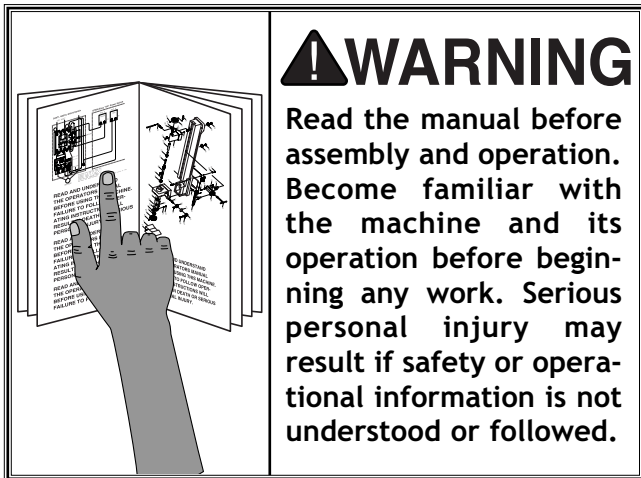

ELECTRICAL REQUIREMENTS

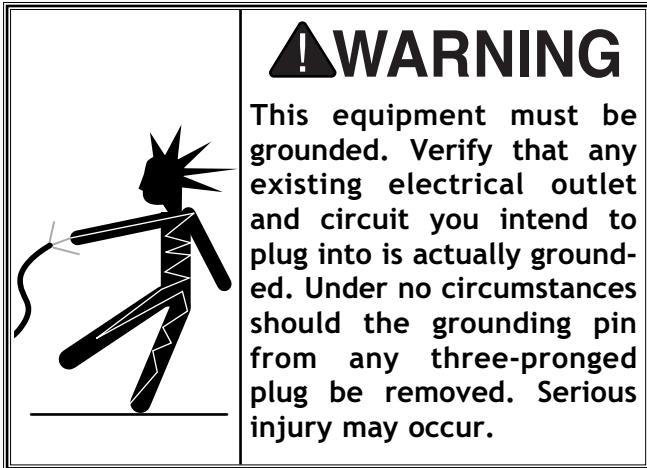

110V Operation

The Shop Fox® W1676 is prewired for 110 volts. The motor supplied with your new machine is rated at 1 H.P. and will draw approximately 14 amps. When choosing an outlet for this machine, consider using one with a 15 amp circuit breaker or fuse. Keep in mind that a circuit being used by other machines or tools at the same time will add to the electrical load being applied to the circuit. Add up the load ratings of all machines on the circuit. If this number exceeds the rating of the circuit breaker or fuse, use a different circuit.

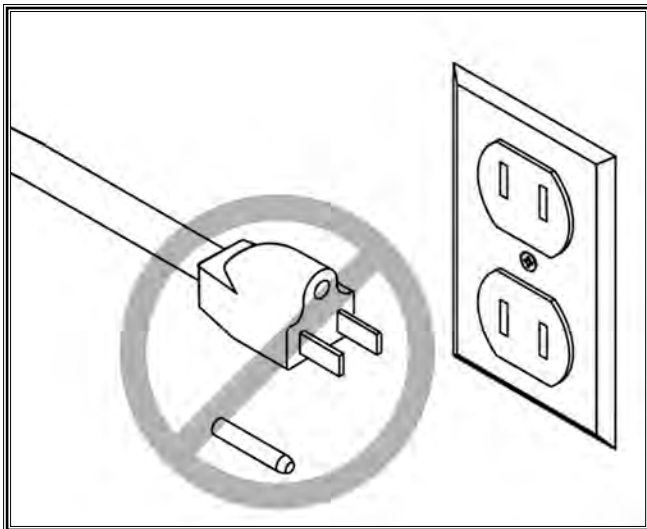

Figure 1. Never remove grounding pin.

Extension Cords

When it is necessary to use an extension cord, use the following guidelines:

- Use cords rated for Hard Service (Grade S)
- Never exceed a length of 100 feet
- Use cords with 14 ga. wire or bigger (12 ga., 10 ga., etc.)
- Ensure cord has a ground wire and pin
- Do not use cords in need of repair

Grounding

This machine must be grounded! See Figure 1A. The electrical cord supplied with the W1676 comes with a grounding pin. Do not remove it. If your outlet does not accommodate a ground pin, have it replaced by a qualified electrician or have an appropriate adapter installed. Please note: when using an adapter, the adapter must be grounded.

An adapter with a grounding wire does not guarantee machine will be grounded. Ground source must be verified.

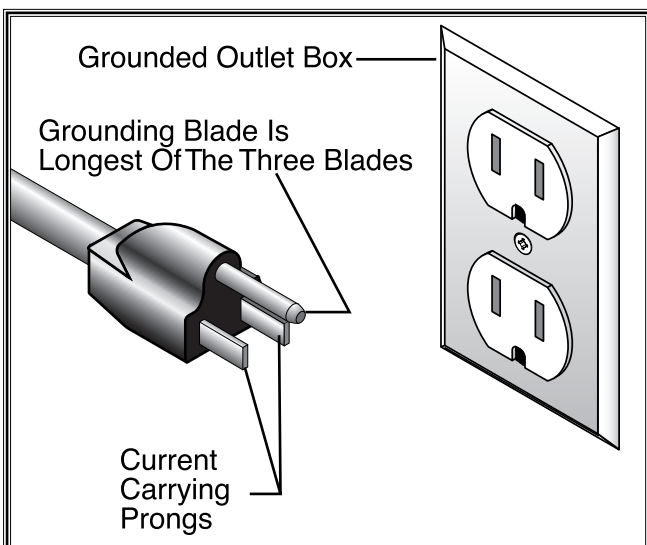

Figure 1A. Typical 110V 3-prong plug and outlet.

220V Operation

The Shop Fox® W1676 can also be operated at 220 volts. To do this, consult with the wiring diagram in the back of this manual for rewiring instructions. Also, you will need a NEMA-style 6-15 plug and outlet.

The motor supplied with your new machine is rated at 1 H.P. and will draw approximately 7 amps during 220 volt operation. When choosing an outlet for this machine, consider using one with a 15 amp circuit breaker or fuse. Keep in mind that a circuit being used by other machines or tools at the same time will add to the total load being applied to the circuit. Add up the load ratings of all machines on the circuit. If this number exceeds the rating of the circuit breaker or fuse, use a different circuit.

Extension Cords

We do not recommend using an extension cord for 220V equipment. Instead, arrange the placement of your machinery and installed wiring to eliminate the need for extension cords. If you must use an extension cord, make sure it is rated Hard Service (grade 5) or better. The extension cord must always contain a ground wire and plug pin. Always repair or replace extension cords when they become worn or damaged.

Grounding

This machine must be grounded! See **Figure 2**. The electrical cord supplied with the W1676 does not come with a 220 volt plug. Use a plug with a ground pin. If your outlet does not accommodate a ground pin, have it replaced by a qualified electrician or have an appropriate adapter installed and grounded properly. An adapter with a grounding wire does not guarantee machine will be grounded. Ground source must be verified.

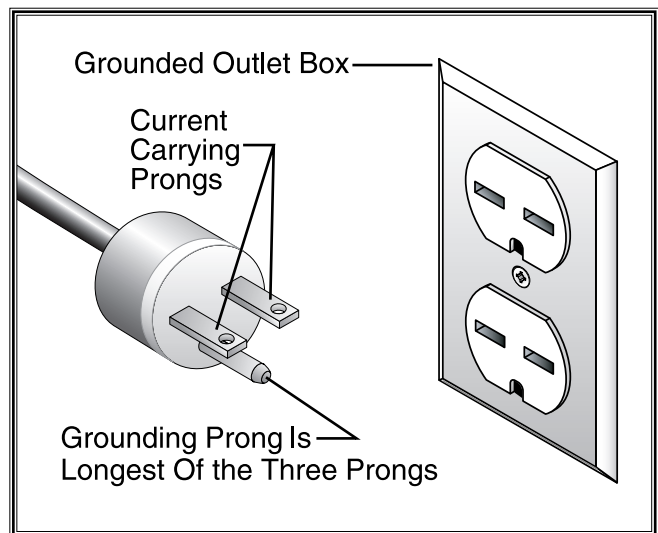
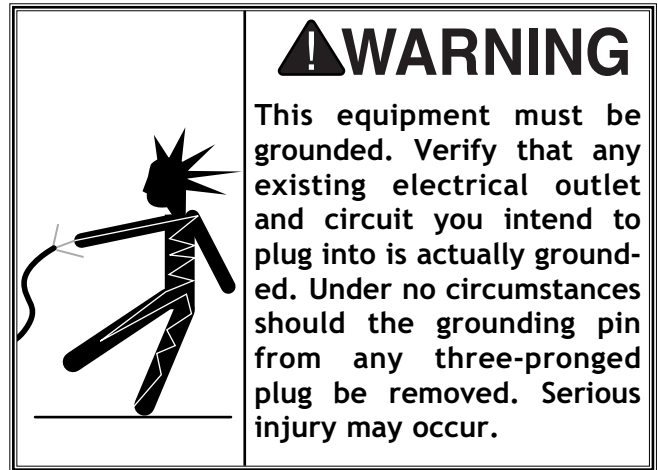

Figure 2. NEMA-style 6-15 plug and outlet.

NOTICE

Never replace the circuit breaker with one rated at a higher amperage or damage to the circuit may occur.

AVOIDING POTENTIAL INJURIES



Figure 3. Never place fingers close to moving disk.



Figure 4. Never use the right side of disk.
Upward rotation of disk can propel workpiece into the air.



Figure 5. Always unplug sander when adjusting.



Figure 6. Never place hands near back stop.
On small workpieces always use push blocks.

ASSEMBLY INSTRUCTIONS

Unpacking

The Model W1676 has been carefully packaged for safe transporting. If you notice the machine has been damaged or is missing any parts, please contact the store where you purchased the machine.

| | |
|--|---|
|  | <p>⚠ CAUTION</p> <p>Make your shop “child safe.” Ensure that your workplace is inaccessible to youngsters by closing and locking all entrances when you are away. Never allow visitors in your shop when assembling, adjusting or operating equipment.</p> |
|--|---|

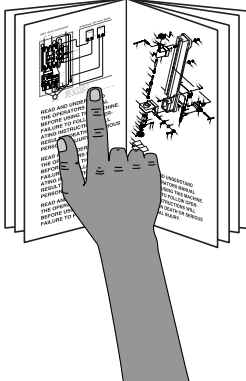
| | |
|--|--|
|  | <p>⚠ WARNING</p> <p>Read the manual before assembly and operation. Become familiar with the machine and its operation before beginning any work. Serious personal injury may result if safety or operational information is not understood or followed.</p> |
|--|--|

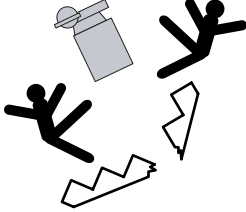
| | |
|---|--|
|  | <p>⚠ WARNING</p> <p>If moving this machine up or down stairs, the machine must be dismantled and moved in smaller pieces. Make sure floor and stair structures are capable of supporting the combined weight of the machine parts and the people moving them.</p> |
|---|--|

| | |
|--|--|
|  | <p>⚠ CAUTION</p> <p>The W1676 represents a heavy load at 170 pounds. Seek assistance before beginning assembly.</p> |
|--|--|

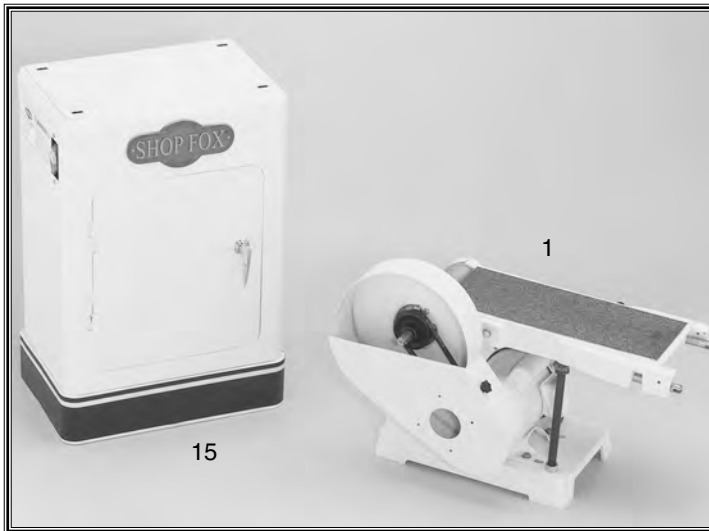

Figure 7. Stand and sanding unit.

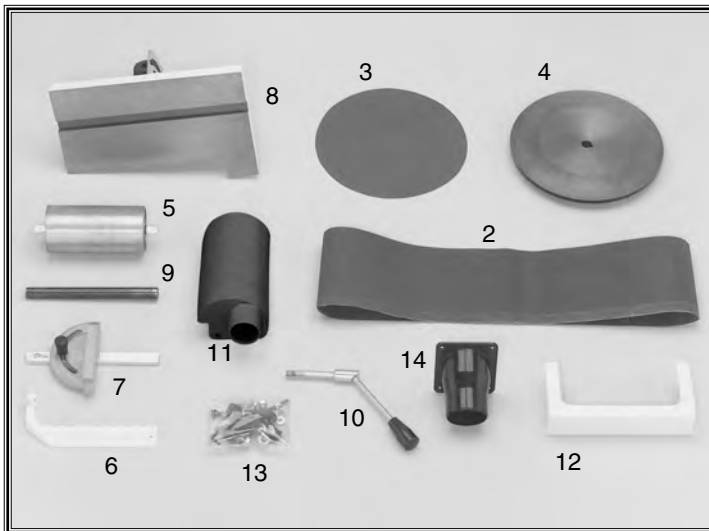

Figure 8. Component layout.

The following is a description of the components shipped with the Shop Fox® W1676. It is recommended that the components be laid out in a similar fashion to those in **Figures 7 and 8**. This will help in identification before beginning assembly. Should any part be missing, examine the packaging carefully. If any key parts are missing, call Woodstock International, Inc. at 360-734-3482 or e-mail: tech-support@woodstockint.com.

| Item | QTY. |
|---------------------------|------|
| 1. Sanding Unit | 1 |
| 2. Sanding Belt | 1 |
| 3. Sanding Disc | 1 |
| 4. Cast Iron Disc | 1 |
| 5. Idler Roller | 1 |
| 6. Back Stop | 1 |
| 7. Miter Gauge | 1 |
| 8. Work Table | 1 |
| 9. Table Support Rod | 1 |
| 10. Quick Release Handle | 1 |
| 11. Dust Port | 1 |
| 12. Idler Roller Guard | 1 |
| 13. Bolt Bag | 1 |
| 14. 2 1/2" Dia. Dust Port | 1 |
| 15. Cabinet Stand | 1 |

Contents of the Bolt Bag

| QTY. | DESCRIPTION | LOCATION |
|------|---------------------------|-------------|
| 4 | 5/16"-18 x 1/2" Hex Bolts | Stand/Base |
| 4 | 5/16" Flat Washers | Stand/Base |
| 4 | 5/16"-18 x 1" Hex Bolts | Stand /Feet |
| 4 | 5/16" Flat Washers | Stand /Feet |
| 4 | 5/16"-18 Hex Nuts | Stand /Feet |
| 4 | 3/16" Phillips® Screws | Dust Port |
| 4 | 3/16" Washers | Dust Port |
| 4 | 3/16" Hex Nuts | Dust Port |
| 1 | Long 4mm Allen® Wrench | |
| 4 | Rubber Feet | Stand /Feet |

Clean Up

The exposed, unpainted surfaces of the machine have been coated with an oil to prevent rust during shipment. This oil needs to be removed before operation. To remove the oil, we recommend using a solvent based degreaser. Avoid using any chlorine based solutions because they will damage the painted surfaces. Always follow the instructions of the product being used.

| | |
|--|--|
|  | <p>⚠ WARNING</p> <p>Do not use gasoline or other petroleum-based solvents. They have low flash points which make them extremely flammable. A risk of explosion and burning exists if these products are used. Serious personal injury may occur if this warning is ignored.</p> |
|--|--|

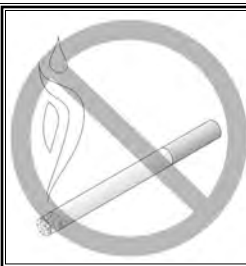
| | |
|--|---|
|  | <p>⚠ WARNING</p> <p>Do not smoke while using solvents. A risk of explosion or fire exists and may result in serious personal injury.</p> |
|--|---|

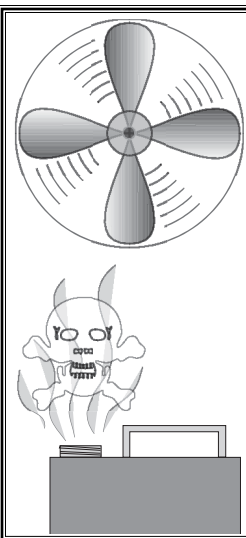
| | |
|---|--|
|  | <p>⚠ CAUTION</p> <p>Many of the solvents commonly used to clean machinery can be toxic when inhaled or ingested. Always work in well-ventilated areas far from potential ignition sources when dealing with solvents. Use care when disposing of waste rags and towels to be sure they do not create fire or environmental hazards.</p> |
|---|--|

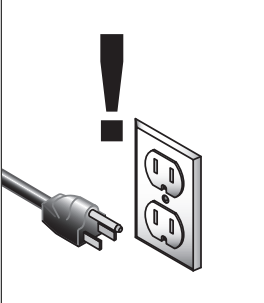

! WARNING
Disconnect power to the machine when performing any maintenance, assembly or adjustments. Failure to do this may result in serious personal injury.



! WARNING
Keep loose clothing rolled up and out of the way of machinery and keep hair pulled back.



! WARNING
Wear safety glasses during the entire assembly process. Failure to comply may result in serious personal injury.

General

While the main components of the Shop Fox® W1676 are assembled at the factory, some assembly is required. The following is the recommended sequence best suited for final assembly.

TOOLS REQUIRED (NOT INCLUDED): You will need a 6" adjustable wrench, 12mm open-end wrench, flathead screwdriver, Phillips® screwdriver and 4mm Allen® wrench.

Sanding Unit To Base

The Model W1676 comes with a prefabricated welded steel stand that requires no assembly. However, the sanding unit needs to be mounted to the stand.

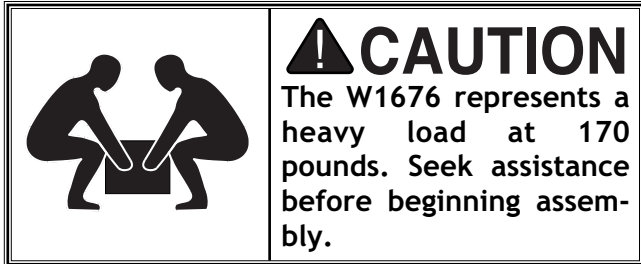

1. With the help of a friend, lift the main sanding unit on top of the steel stand.
2. Align the four mounting holes in the stand with the slots on the bottom corners of the sanding unit as shown in **Figure 9**.
3. Using (4) $\frac{5}{16}$ "-18 x $\frac{1}{2}$ " hex bolts, $\frac{5}{16}$ " washers and $\frac{5}{16}$ " nuts, fasten the sanding unit to the stand.

Idler Roller

Install the idler roller by inserting its flat axle ends into the slots on the ends of the adjustments bar as shown in **Figure 10**.



Sanding Disc

The sanding disc is installed onto the keyed drive shaft using a $\frac{5}{16}$ "-18 x $\frac{3}{8}$ " setscrew as shown in **Figure 11**. For clearance purposes, we have included a long shaft 4mm Allen® wrench.



Figure 9. Stand mounting holes.

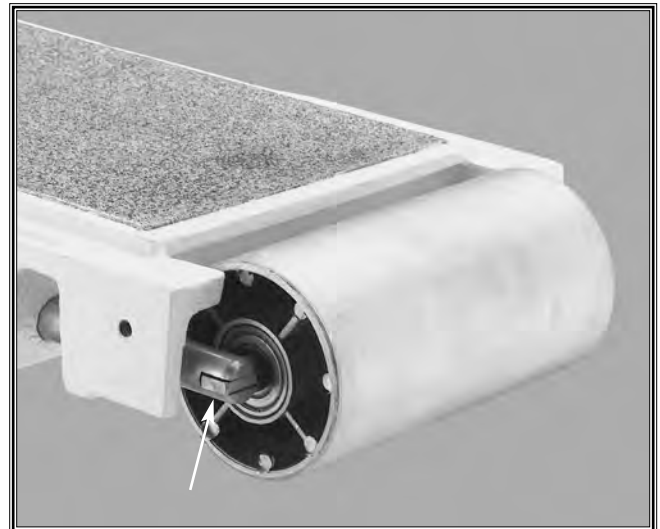

Figure 10. Idler roller.



Figure 11. Installing sanding disk.

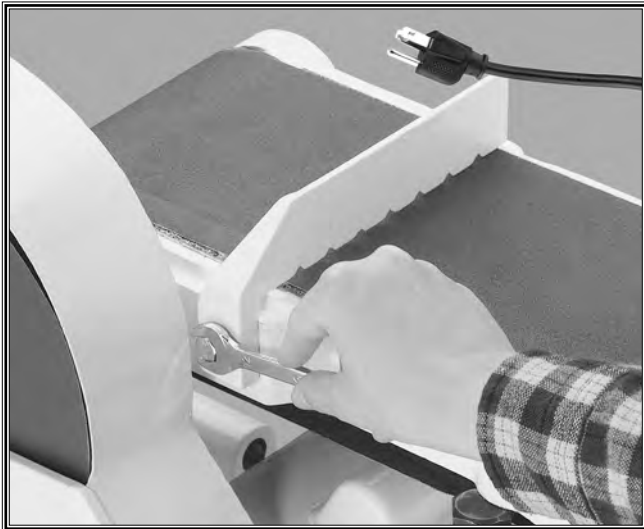

Figure 12. Installing back stop.

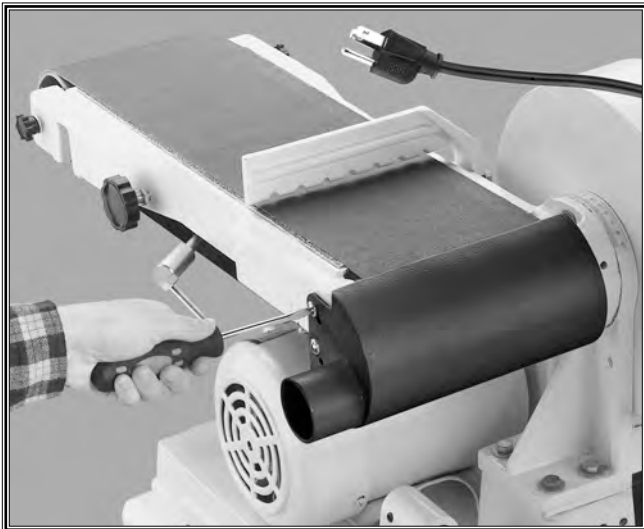

Figure 13. Installing dust port.

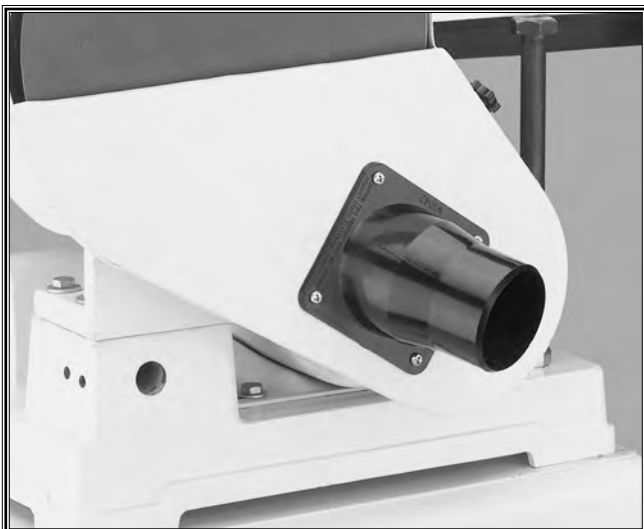

Figure 14. Disc sanding dust port.

Back Stop

The back stop serves as a resting point for the workpiece while flat sanding on the belt. Install the back stop to the sanding belt frame using a $\frac{5}{16}$ "-18 x 1" hex bolt and a $\frac{5}{16}$ " flat washer as shown in **Figure 12**. The back stop can be removed when sanding long workpieces.

Dust Ports

The dust ports are designed to reduce the amount of dust on the sander and in the air. Fasten the belt dust port to the sanding belt frame using (2) Phillips® head screws as shown in **Figure 13**. Fasten the disc dust port using (4) Phillips® head screws and nuts as shown in **Figure 14**.

| | |
|--|--|
| | <p>⚠ CAUTION</p> <p>Always wear a dust mask when operating the W1676. Using this machine produces sawdust which may cause allergic reactions or respiratory problems.</p> |
|--|--|

Working Table

The working table has two mounting locations: next to the sanding disc and next to the vertically positioned belt sander. We recommend initially mounting the working table next to the disc. If you want to mount it next to the vertically positioned belt sander, skip to the "Vertical Positioning" instructions in the Adjustment section.

To install the working table next to the disc:

1. Loosen the (2) $\frac{5}{16}$ "-18 x $\frac{3}{8}$ " setscrews located in the base, directly beneath the pulley cover.
2. Insert the support bar into the hole in the base that is adjacent to the setscrew holes. Make sure that the flat side of the support bar is facing the setscrews.
3. Securely tighten the setscrews as shown in Figure 15.
4. Slide the working table assembly onto the end of the support bar and securely tighten the setscrews located in the table support bracket as shown in Figure 16. Be sure to leave no more than a $\frac{1}{16}$ " gap between the disc and the edge of the working table.

Quick Release

The quick release lever is used to loosen the tension on the sanding belt. To install the quick release lever:

1. Thread a $\frac{3}{8}$ "-16 hex nut on each end of the quick release levers.
2. Thread the ends of the levers into the threaded holes in the short lever and the rocker arm.
3. Finally, position the levers as shown in Figure 17 and tighten down the hex nuts.



Figure 15. Tightening the setscrews.



Figure 16. Tightening the setscrews.

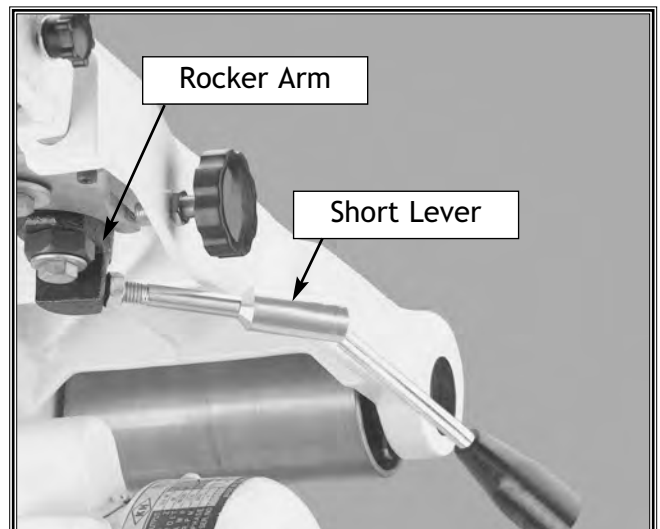
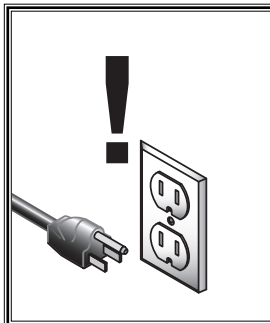

Figure 17. Installing the quick release.

ADJUSTMENTS

| | |
|---|---|
|  | <p>! WARNING Disconnect power to the machine when performing any maintenance, assembly or adjustments. Failure to do this may result in serious personal injury.</p> |
|---|---|

| | |
|---|--|
|  | <p>! WARNING Keep loose clothing rolled up and out of the way of machinery and keep hair pulled back.</p> |
|---|--|

| | |
|--|---|
|  | <p>! WARNING Wear safety glasses during the entire adjustments process. Failure to comply may result in serious personal injury.</p> |
|--|---|

General

The Model W1676 is capable of a wide variety of sanding operations. The sanding belt can be positioned in a variety of angles ranging from 0-90° and can accommodate the working table in the vertical position. The sanding disc can accommodate the working table at a variety of angles ranging from 0-45°. In all, the Model W1676 will be a welcome addition to the home or commercial workshop. The following section will go through the above adjustment steps.

Belt Tracking/Tension

NOTICE

It is best to adjust the tracking of the sanding belt before making any tension adjustments. If you have trouble maintaining proper tracking after several attempts, you may need to adjust the belt tension. Improper tension can often times be the cause of tracking problems.

Belt tension and tracking are crucial to the performance of the belt sander. Too much tension will cause undue stress on the bearings and other parts. Too little tension will cause the sanding belt to not track properly and fall off the sanding belt frame. It is better to have the least amount of tension required to make the belt track properly while under load.

To adjust the tracking:

1. **Unplug the combination sander!**
2. Unlock the quick release lever on the side of the sanding unit by shifting it to the left.
3. Slide a 6" x 48" sanding belt onto the belt sanding frame as shown in **Figure 18**.
4. Shift the quick release lever to the right to tension the sanding belt.
5. To check the tracking, plug in and quickly turn the sander on and off, and watch the path of the belt. If it moves to either side, the tracking needs to be adjusted.
6. Turn the tracking knob $\frac{1}{4}$ turn clockwise to adjust the sanding belt towards the tracking knob, and turn counter-clockwise to adjust the sanding belt away from the tracking knob as shown in **Figure 19**.
7. Quickly turn the machine on and off again to see if the tracking has improved. If not, repeat the above steps.
8. If the tracking is fairly well maintained, leave the machine running and fine tune the sanding belt by further adjusting the tracking knob.



Figure 18. Installing the sanding belt.

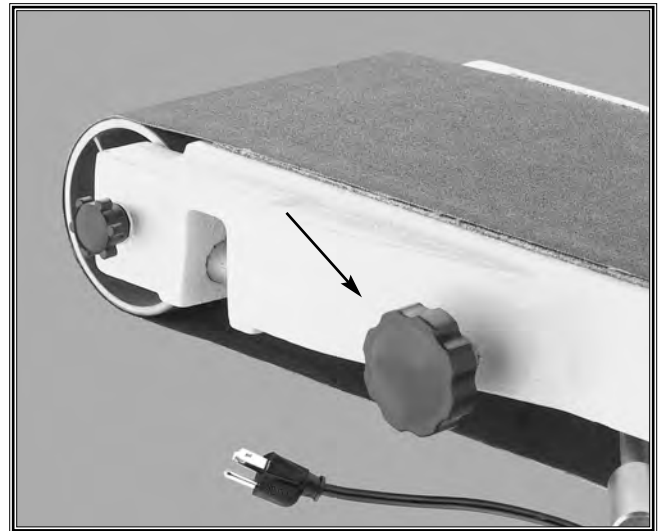

Figure 19. Knob for adjusting tracking.

CAUTION

Always install belt according to the arrow direction on the inside of the belt. Belts installed incorrectly can fall apart, causing serious personal injury.

Belt Tracking/Tension Continued

Gauging proper belt tension is very subjective. The easiest way to check the tension is to pluck the edge of the sanding belt. If it sounds like a drum, the tension is probably too tight.

To adjust the tension:

1. With the belt installed and the quick release lever engaged, loosen the hex bolt located at the pivoting point of the rocker arm as shown in **Figure 20**. Do not remove the bolt.
2. Using an adjustable wrench as shown in **Figure 21**, rotate the large eccentric bolt head to either increase or decrease the belt tension.
3. When the proper tension is achieved, tighten the hex bolt that was loosened in **Step 1**, while maintaining the position of the eccentric bolt with a wrench.
4. Run the sander again to check and adjust the tracking.
5. Using a scrap piece of wood, aggressively sand on the belt to see if proper tracking is maintained. If not, repeat the tracking adjustment steps on the previous page.

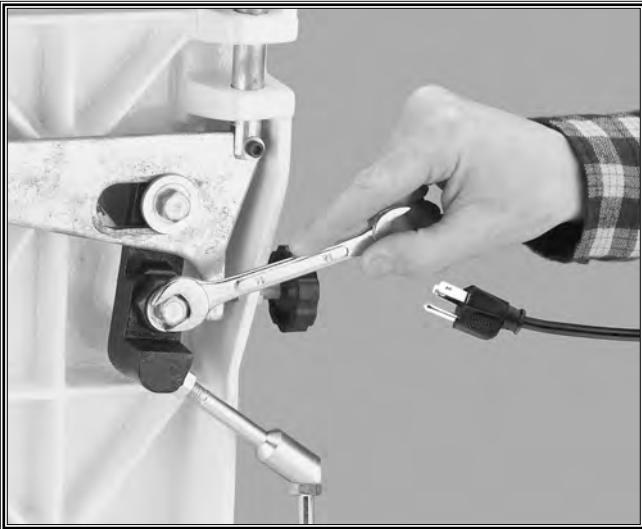

Figure 20. Loosening rocker arm bolt.
(Belt Removed For Clarity)



Figure 21. Loosening eccentric bolt head.
(Belt Removed For Clarity)

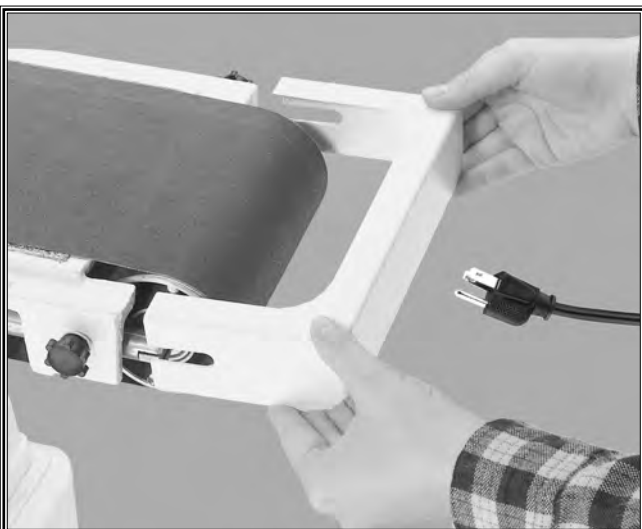

Figure 22. Installing idler guard.

Idler Guard

Once the belt tension and tracking are properly set, install the idler guard as shown in **Figure 22**. Tighten the lock down knobs on each side.

Vertical Positioning

The belt sander arm can be moved to a vertical arrangement.

1. Remove the belt dust port.
2. Loosen the two nuts located on the bracket behind the pulley cover as shown in **Figure 23**. We recommend using a 12mm open-end wrench for clearance purposes.
3. When the nuts are loose, rotate the sanding belt frame to the vertical position as shown in **Figure 24**.
4. Tighten down the nuts that were loosened in **Step 2**.

The working table can also be repositioned next to the vertical surface of the sanding belt. Remove the working table assembly and support bar from the sander base, and reposition it in the mounting hole behind the motor as shown in **Figure 25**.

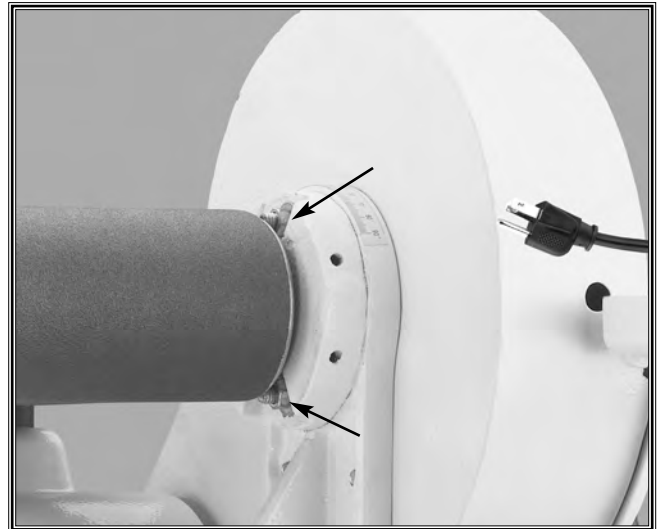

Figure 23. Vertical positioning bolts.



Figure 24. Belt sander in vertical position.



Figure 25. Working table mounting hole when vertical sanding.



Figure 26. Opening pulley door.

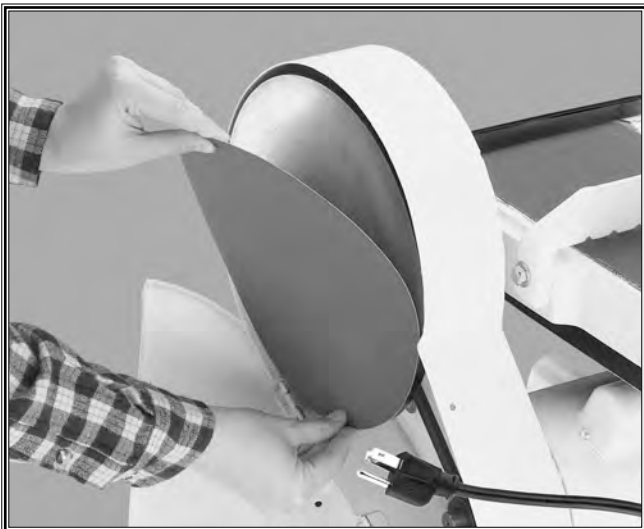

Figure 27. Changing abrasive disc with table off.



Figure 28. Changing abrasive disc with table on.

Changing Abrasive Disc

To replace abrasive sanding disc:

1. Remove the working table assembly.
2. Remove the knob holding the pulley cover door shut and open the door as shown in **Figure 26**.
3. Remove the worn sanding disc and the new sanding disc. Be sure to center the new sanding disc over the cast iron disc before pressing it down as shown in **Figure 27**.
4. Another option allows you to leave the pulley cover and working table attached. Peel back half of the abrasive disc backing and slip the covered portion behind the closed pulley door. Stick the peeled back portion of the abrasive disc to the top half of the sanding wheel. Carefully rotate the disc 180°. Peel back the second half of the abrasive backing and stick the remaining portion to the sanding disc as shown in **Figure 28**. Press then entire disc on to ensure good adhesion.

Table Tilt

To adjust the working table angle:

1. Set the working table angle to the 90° mark on the scale.
2. Using a 90° square, adjust the working table so it is perpendicular to the sanding disc as shown in **Figure 29**.
3. Loosen the screw holding the angle indicator and set it to the 90° mark on the scale.
4. Using a 90° square, check to see if the miter slot is perpendicular to the sanding disc as shown in **Figure 30**.
5. To adjust, loosen the three screws shown in **Figure 31**. Wiggle the table until the miter slot is parallel to the sanding disc and tighten the adjustment screws.



Figure 29. Checking table alignment.

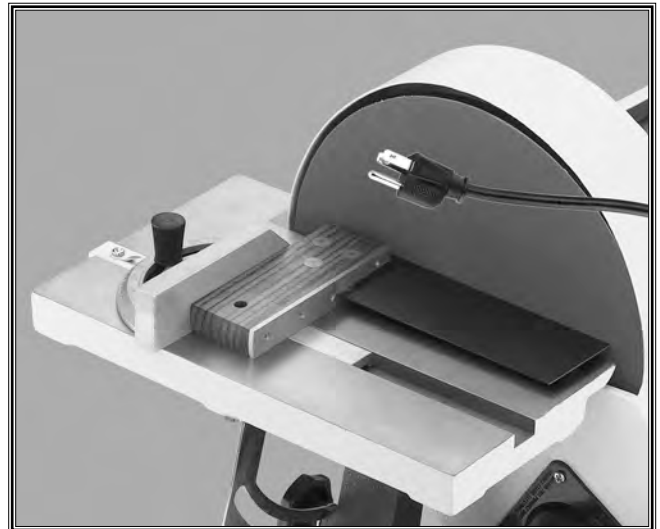

Figure 30. Checking miter gauge alignment.

WARNING

Make sure the gap between the working table edge and the sanding disc is no larger than $\frac{1}{8}$ ". Your fingers could get caught in the gap, causing serious personal injury.

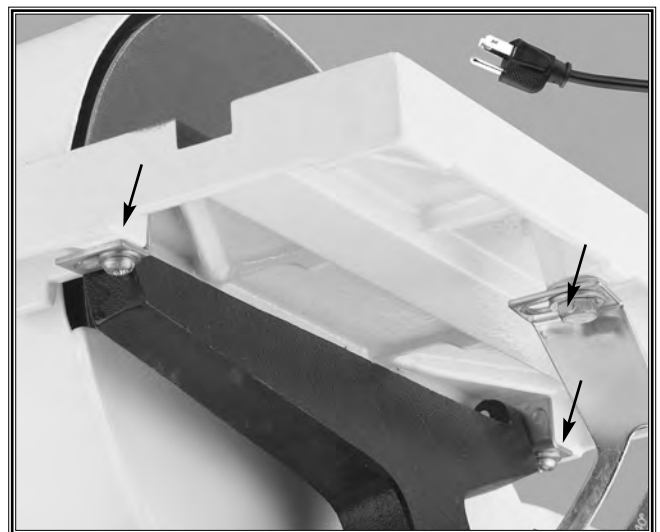

Figure 31. Table adjustment screws.

OPERATIONS

| | |
|--|--|
| | <p>⚠ WARNING Disconnect power to the machine when performing any maintenance, assembly or adjustments. Failure to do this may result in serious personal injury.</p> |
|--|--|

| | |
|--|---|
| | <p>⚠ WARNING Keep loose clothing rolled up and out of the way of machinery and keep hair pulled back.</p> |
|--|---|

| | |
|--|---|
| | <p>⚠ WARNING Wear safety glasses during the entire operations process. Failure to comply may result in serious personal injury.</p> |
|--|---|

| | |
|--|--|
| | <p>⚠ CAUTION Always wear a dust mask when operating the W1676. Using this machine produces sawdust which may cause allergic reactions or respiratory problems.</p> |
|--|--|

Testing

Once assembly is complete and adjustments have been made, the machine is ready for a test run. The purpose of a test run is to identify any unusual noises and vibrations, as well as to confirm the machine is performing as intended.

1. Turn the machine on by pulling the START paddle on the power switch. Be sure to have your finger poised to push the paddle in if there is a problem.
2. Once the machine is running, listen for any unusual noises. The machine should run smoothly with little or no vibrations.
3. If there are any unusual noises or vibrations, shut the machine off immediately. The machine should not be run any further until the problems are corrected.
4. Unplug the machine and investigate the source of the noise or vibration. Do not make any adjustments to the machine while it is plugged in.

Horizontal Sanding

1. Turn the power on and allow the sander to reach full speed.
2. Place the workpiece against the surface of the sanding belt. Make sure you have both hands securely on the workpiece and keep fingers and hands away from sanding surface as shown in **Figure 32**.
3. Use the back stop to prevent the workpiece from being propelled off of the sander.
4. If the workpiece is long, you may want to remove the back stop from the sander. Take care to hold the workpiece securely when the back stop is removed as shown in **Figure 33**.

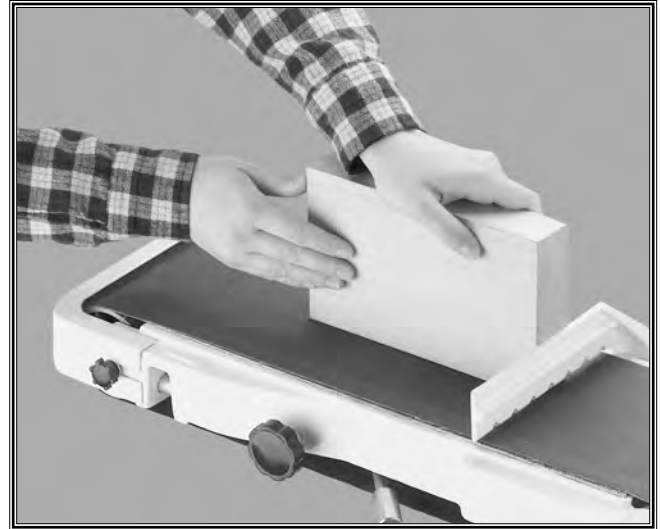

Figure 32. Sanding with back stop.

Curved Sanding

Concave curves can be sanded on the idler roller.

1. Remove the idler roller guard from the sander.
2. Hold the workpiece against the idler roller, slowly moving the workpiece back and forth to prevent heat build up as shown in **Figure 34**.
3. The smallest concave curve that can be sanded is equal to the radius ($1\frac{3}{4}$ ") of the idler roller.



Figure 33. Sanding without back stop.

| | |
|--|---|
| | <p>⚠️ WARNING Keep fingers and clothing away from the sanding back stop. Failure to comply may result in serious personal injury.</p> |
|--|---|

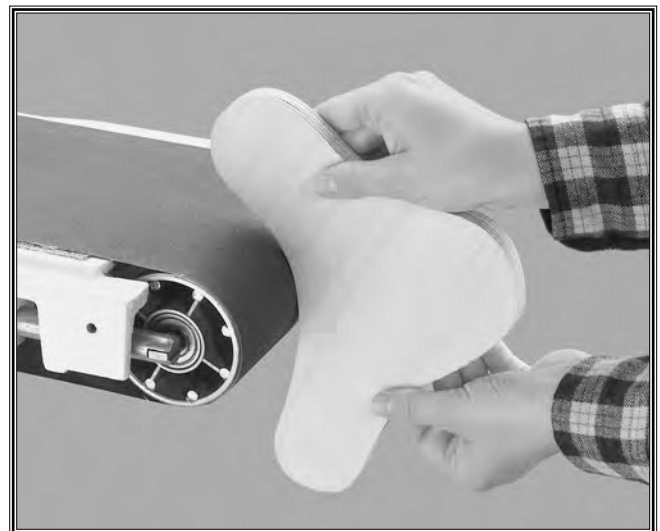

Figure 34. Curved sanding on idler roller.



Figure 35. Sanding end grain.



Figure 36. Using miter gauge to sand angles.



Figure 37. Using table to sand angles.

Disc Sanding

The disc is best used for sanding end grain and convex curves.

1. Set the working table to the desired angle.
2. Always use the left half of the disc. (The half that is rotating downward.)
3. Set the miter gauge at 90° to keep the workpiece perpendicular to the sanding disc as shown in **Figure 35**.
4. Varying angles can be sanded by adjusting the miter gauge to the desired setting as shown in **Figure 36**.
5. When the table is set at an angle, the gap between the disc and the table becomes greater (**Figure 37**); therefore, use extra care to prevent small pieces and fingers from becoming lodged in the gap.

CAUTION

Only use the left half of the sanding disc when performing sanding operations. The right half of the disc is rotating in an upward direction and if used could cause the workpiece to be propelled into the air. Serious injury could occur.

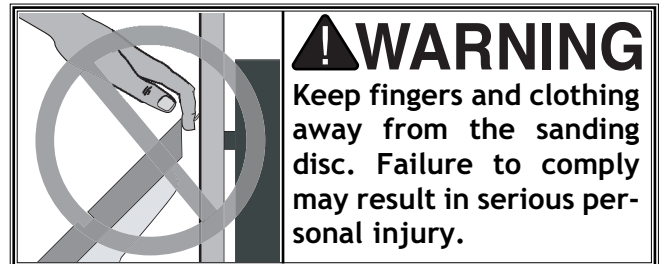

MAINTENANCE

General

Regular periodic maintenance on your Model W1676 will ensure its optimum performance. Make a habit of inspecting your sander each time you use it. Check for the following conditions and repair or replace when necessary.

1. Loose mounting bolts.
2. Worn switch.
3. Worn or damaged cords and plugs.
4. Damaged sanding belts or discs.
5. Any other condition that could hamper the safe operation of this machine.

Table And Base

Tables can be kept rust-free with regular applications of products like Boeshield® T-9. For long term storage you may want to consider products like Kleen Bore's Rust Guardit™.

Lubrication

Since all bearings are sealed and permanently lubricated, simply leave them alone until they need to be replaced. Do not lubricate them.

For other items on this machine, an occasional application of light machine oil is all that is necessary. Before applying lubricant, wipe the machine clean.

Your goal is to achieve adequate lubrication. Too much lubrication will attract dirt and sawdust. Various parts of your machine could lose their freedom of movement as a result.

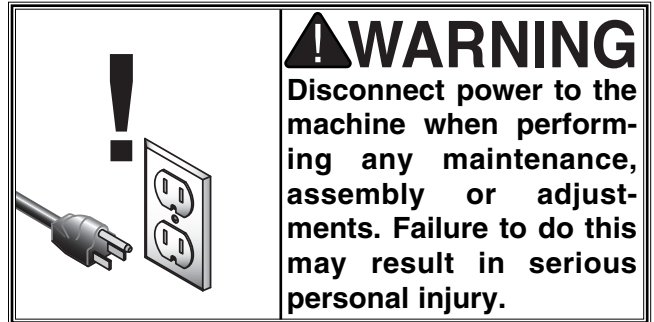

CLOSURE

The following pages contain parts diagrams/lists and a warranty card for your Shop Fox® Model W1676.

If you need parts or help in assembling your machine, or if you need operational information, we encourage you to call our Technical Department. Our trained technical technicians will be glad to help you.

If you have comments dealing specifically with this manual, please write to us using the address in the General Information. The specifications, drawings, and photographs illustrated in this manual represent the Model W1676 as supplied when the manual was prepared. However, due to Woodstock International, Inc.'s policy of continuous improvement, changes may be made at any time with no obligation on the part of Woodstock International, Inc. Whenever possible, though, we send manual updates to all owners of a particular tool or machine that have registered their purchase with our warranty card. Should you receive one, add the new information to this manual and keep it for reference.



We have included some important safety measures that are essential to this machine's operation. While most safety measures are generally universal, we remind you that each workshop is different and safety rules should be considered as they apply to your specific situation.

| |
|---|
| <p>⚠ WARNING</p> <p>As with all power tools, there is danger associated with the Model W1676. Use the tool with respect and caution to lessen the possibility of mechanical damage or operator injury. If normal safety precautions are overlooked or ignored, injury to the operator or others in the area is likely.</p> |
|---|

We recommend you keep this manual for complete information regarding Woodstock International, Inc.'s warranty and return policy. Should a problem arise, we recommend that you keep your proof of purchase with your manual. If you need additional technical information relating to this machine, or if you need general assistance or replacement parts, please contact the Service Department at 1-360-734-3482 or e-mail: tech-support@woodstockint.com.

Additional information sources are necessary to realize the full potential of this machine. Trade journals, woodworking magazines, and your local library are good places to start.

The Model W1676 is specifically designed for sanding operations. **DO NOT MODIFY AND/OR USE THIS SANDER FOR ANY OTHER PURPOSE. MODIFICATIONS OR IMPROPER USE OF THIS TOOL WILL VOID THE WARRANTY.** If you are confused about any aspect of this machine, **DO NOT** use it until all your questions have been answered.

| | | |
|---|---|---|
| <p>⚠ WARNING</p> <p>Operating this equipment creates the potential for flying debris to cause eye injury. Always wear safety glasses or goggles when operating equipment. Everyday glasses or reading glasses only have impact resistant lenses, they are not safety glasses. Be certain the safety glasses you wear meet the appropriate standards of the American National Standards Institute (ANSI).</p> | | |
|  |  |  |



W1676 Combination Sander

110 VOLT

⚠ DANGER
Disconnect power from machine before performing any electrical service. Failure to do this will result in a shock hazard leading to injury or death.

NOTE: THE WIRES FROM THE POWER SUPPLY, BESIDES THE GREEN GROUND WIRE, ARE INTERCHANGABLE, THEREFORE COLORS ARE NOT SPECIFIED.

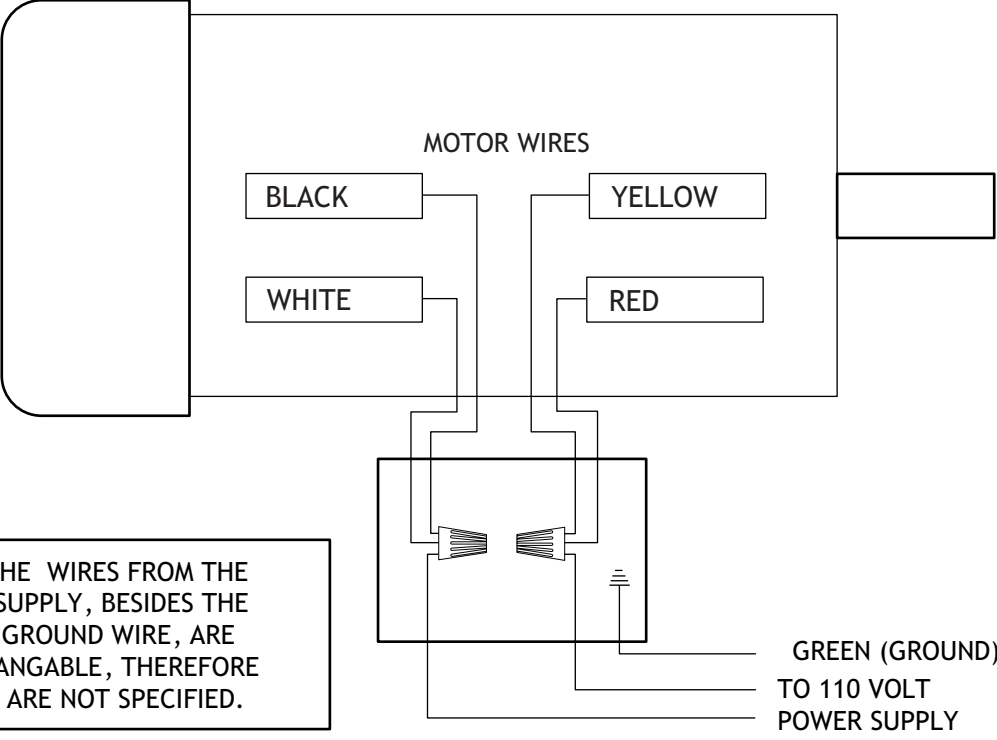

220VOLT

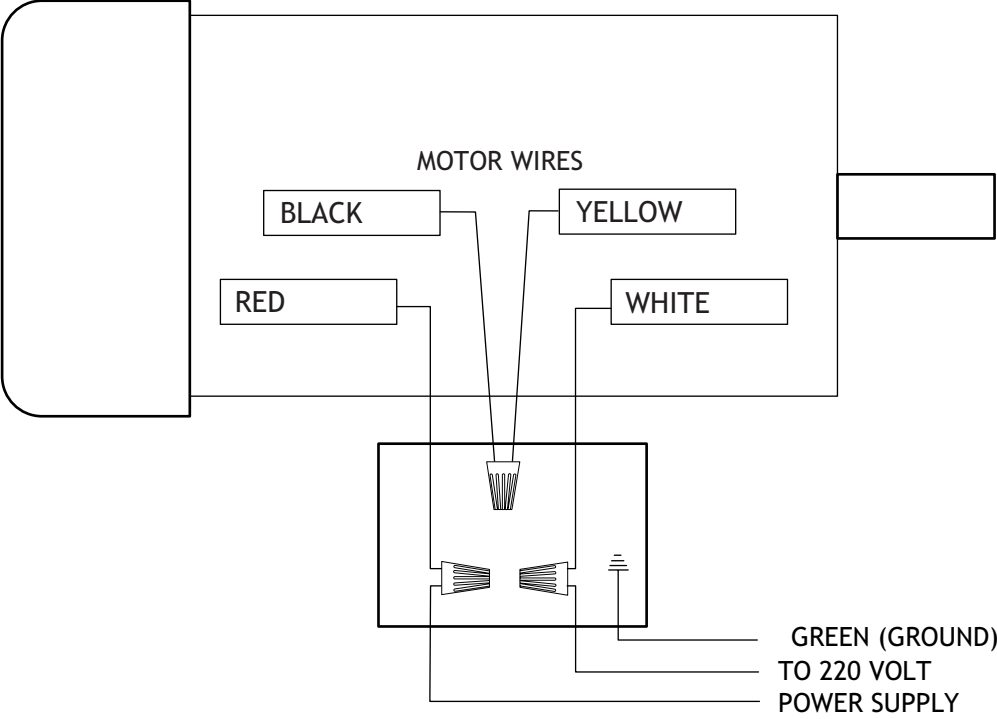

6A

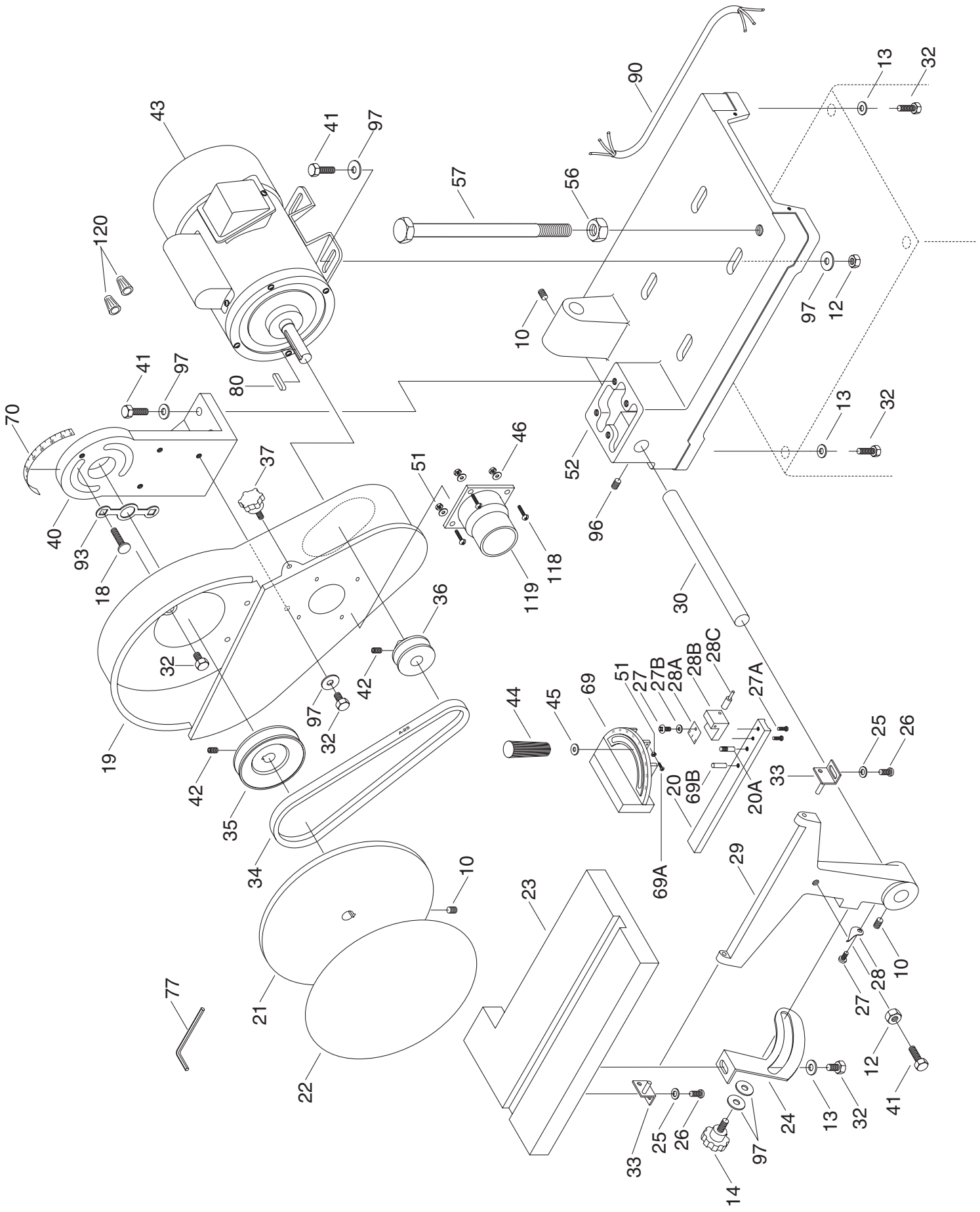

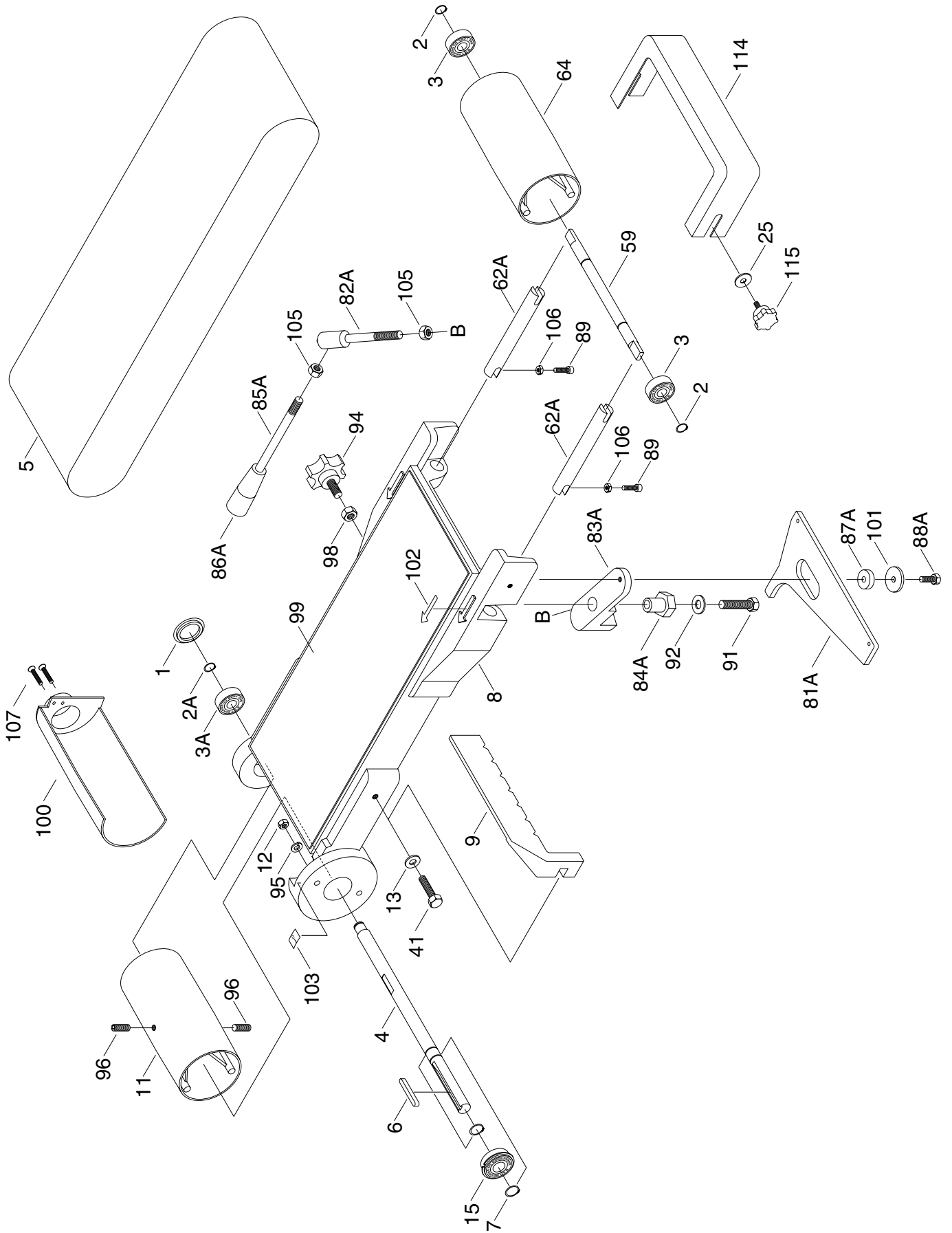

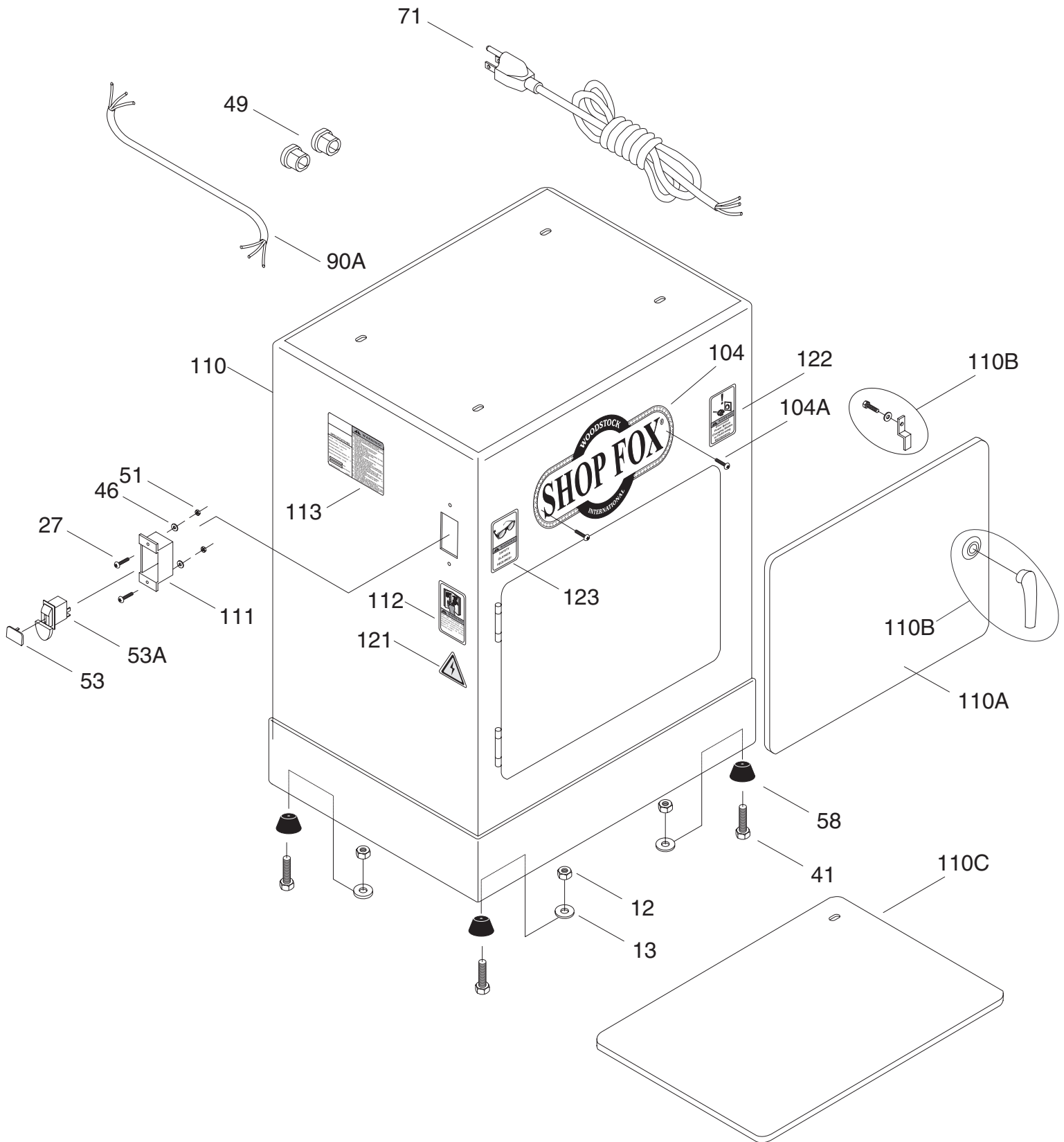

| REF | PART # | DESCRIPTION |
|-----|------------|---------------------------------|
| 01 | X1676001 | DUST COVER |
| 02 | XPR03M | SNAP RING 12MM |
| 02A | XPR05M | SNAP RING 15MM |
| 03 | XP6201-2RS | BALL BEARING 6201-2RS |
| 03A | XP6002-2RS | BALL BEARING 6002-2RS |
| 04 | X1676004 | DRIVE SHAFT |
| 05 | X1676005 | SANDING BELT 6" X 48" |
| 06 | XPK02M | KEY 5 X 5X 40 |
| 07 | X1676007 | SNAP RING 16MM |
| 08 | X1676008 | SANDING BELT FRAME |
| 09 | X1676009 | BACK STOP |
| 10 | XPSS02 | SETSCREW 5/16"-18 x 3/8" |
| 11 | X1676011 | DRIVE ROLLER |
| 12 | X1676012 | HEX NUT 5/16"-18 |
| 13 | X1676013 | 5/16" FLAT WASHER |
| 14 | X1676014 | KNOB |
| 15 | X1676015 | BEARING 6003-2RS |
| 16 | X1676016 | COMPLETE MITER GAUGE ASSY |
| 18 | X1676018 | CARRIAGE BOLT 5/16"-18 x 1 1/4" |
| 19 | X1676019 | PULLEY COVER |
| 20 | X1676020 | MITER BAR |
| 20A | X1676020A | STUD 1/4" |
| 21 | X1676021 | CAST IRON DISC 10" |
| 22 | X1676022 | SANDING DISC PAPER 10" |
| 23 | X1676023 | TABLE |
| 24 | X1676024 | TRUNNION |
| 25 | XPW06 | FLAT WASHER 1/4" |
| 26 | XPS04 | PHILLIPS® SCREW 1/4"-20 X 1/2" |
| 27 | X1676027 | PHILLIPS® SCREW 10-24 X 1/4" |
| 27A | X1676027A | PHILLIPS® SCREW 10-24 X 3/8" |
| 27B | X1676027B | FLAT WASHER 3/16" |
| 28 | X1676028 | TABLE POINTER |
| 28A | X1676028A | MITER POINTER |
| 28B | X1676028B | LOCK BRACKET |
| 28C | X1676028C | LOCK PIN |
| 29 | X1676029 | TABLE SUPPORT BRACKET |
| 30 | X1676030 | SUPPORT BAR |
| 32 | XPB09 | HEX BOLT 5/16"-18 x 1 1/2" |
| 33 | X1676033 | TABLE MOUNT |
| 34 | X1676034 | V-BELT 3L-240 |
| 35 | X1676035 | PULLEY |
| 36 | X1676036 | MOTOR PULLEY |
| 37 | X1676037 | KNOB |
| 40 | X1676040 | BRACKET |
| 41 | XPB03 | HEX BOLT 5/16"-18 x 1" |
| 42 | XPSS03 | SETSCREW 5/16"-18 x 1/4" |
| 43 | X1676043 | MOTOR |
| 44 | X1676044 | LOCK KNOB |
| 45 | X1676045 | PLASTIC WASHER 1/4" |
| 46 | X1676046 | FLAT WASHER 3/16" |
| 49 | X1676049 | STRAIN RELIEF FITTINGS |
| 51 | X1676051 | HEX NUT 10-24 |
| 52 | X1676052 | BASE |
| 53 | X1676053 | SWITCH LOCK |
| 53A | X1676053A | SWITCH |
| 56 | XPN04 | HEX NUT 5/8"-11 |

| REF | PART # | DESCRIPTION |
|------|-----------|---------------------------------|
| 57 | X1676057 | SUPPORT 5/8"-11 x 9" |
| 58 | X1676058 | RUBBER FOOT |
| 59 | X1676059 | IDLER ROLLER SHAFT |
| 62A | X1676062B | ROLLER ADJ BAR |
| 64 | X1676064 | IDLER ROLLER |
| 69 | X1676069 | MITER BODY |
| 69A | X1676069A | PHILLIPS® SCREW 10-24 x 3/4" |
| 69B | X1676069B | PIN 1/4" |
| 70 | X1676070 | SCALE |
| 71 | X1676071 | POWER CORD |
| 77 | XPAW04M | ALLEN® WRENCH 4MM |
| 80 | XPK23M | KEY 5 X 5 X 25 |
| 81A | X1676081A | ROCKER ARM |
| 82A | X1676082A | LEVER, SHORT |
| 83A | X1676083A | ROCKER ARM |
| 84A | X1676084A | ECCENTRIC |
| 85A | X1676085A | LEVER, LONG |
| 86A | X1676086A | KNOB, 3/8"-16 |
| 87A | X1676087A | SPACER |
| 88A | XPB21 | HEX BOLT 3/8"-16 x 3/4" |
| 89 | XPSB31 | CAP SCREW 10-24 x 5/8" |
| 90 | X1676090 | MOTOR CORD (1) |
| 90A | X1676090A | MOTOR CORD (2) |
| 91 | XPB16 | HEX BOLT 3/8"-16 x 1 1/2" |
| 92 | XPW02 | FLAT WASHER 3/8" |
| 93 | X1676093 | WASHER PLATE |
| 94 | X1676094 | KNOB |
| 95 | XPLW01 | LOCK WASHER 5/16" |
| 96 | XPSS18 | SETSCREW 5/16"-18 x 3/4" |
| 97 | XPW07 | FLAT WASHER 5/16" |
| 98 | XPN11 | HEX NUT 3/8"-24 |
| 99 | X1676099 | GRAPHITE PAD |
| 100 | X1676100 | DUST PORT ABS |
| 101 | X1676101 | FLAT WASHER 3/8" |
| 102 | X1676102 | DIRECTION SCALE |
| 103 | X1676103 | POINTER |
| 104 | X1676104 | LOGO |
| 104A | X1676104A | LOGO SCREW |
| 105 | XPN08 | HEX NUT 3/8"-16 |
| 106 | X1676106 | HEX NUT 10-24 |
| 107 | X1676107 | PHILLIPS® SCREW 3/16"-24 X 3/8" |
| 110 | X1676110 | CABINET |
| 110A | X1676110A | CABINET DOOR |
| 110B | X1676110B | DOOR LATCH SYSTEM |
| 110C | X1676110C | SHELF |
| 111 | X1676111 | SWITCH HOUSING |
| 112 | X1676112 | READ MANUAL WARNING |
| 113 | X1676113 | MACHINE ID/WARNING |
| 114 | X1676114 | IDLER ROLLER GUARD |
| 115 | X1676115 | LOCK KNOB |
| 118 | X1676118 | PHILLIPS® SCREW 3/16"-24 X 3/8" |
| 119 | X1676119 | DUST PORT |
| 120 | X1676120 | WIRE CONNECTOR 1/2" |
| 121 | X1676121 | ELECTRICITY WARNING |
| 122 | X1676122 | UNPLUG WARNING |
| 123 | X1676123 | SAFETY GLASSES WARNING |

Notes

Notes



WARRANTY CARD

Name _____
 Street _____
 City _____ State _____ Zip _____
 Phone Number _____ E-Mail _____ FAX _____

MODEL #W1676 Combination Sander

The following information is given on a voluntary basis and is strictly confidential.

CUT ALONG DOTTED LINE

- Where did you purchase your Shop Fox® machine?

- How did you first learn about us?
 Advertisement Friend
 Mail order Catalog Local Store
 World Wide Web Site
 Other _____
- Which of the following magazines do you subscribe to.
 American Woodworker Today's Homeowner
 Cabinetmaker Wood
 Family Handyman Wooden Boat
 Fine Homebuilding Woodshop News
 Fine Woodworking Woodsmith
 Home Handyman Woodwork
 Journal of Light Construction Woodworker
 Old House Journal Woodworker's Journal
 Popular Mechanics Workbench
 Popular Science American How-To
 Popular Woodworking
 Other _____
- Which of the following woodworking/remodeling shows do you watch?
 Backyard America The New Yankee Workshop
 Home Time This Old House
 The American Woodworker Woodwright's Shop
 Other _____
- What is your annual household income?
 \$20,000-\$29,999 \$60,000-\$69,999
 \$30,000-\$39,999 \$70,000-\$79,999
 \$40,000-\$49,999 \$80,000-\$89,999
 \$50,000-\$59,999 \$90,000 +
- What is your age group?
 20-29 50-59
 30-39 60-69
 40-49 70 +
- How long have you been a woodworker?
 0 - 2 Years 8 - 20 Years
 2 - 8 Years 20+ Years
- How would you rank your woodworking skills?
 Simple Advanced
 Intermediate Master Craftsman
- How many Shop Fox® machines do you own? _____
- What stationary woodworking tools do you own? Check all that apply.
 Air Compressor Panel Saw
 Band Saw Planer
 Drill Press Power Feeder
 Drum Sander Radial Arm Saw
 Dust Collector Shaper
 Horizontal Boring Machine Spindle Sander
 Jointer Table Saw
 Lathe Vacuum Veneer Press
 Mortiser Wide Belt Sander
 Other _____
- Which benchtop tools do you own? Check all that apply.
 1" x 42" Belt Sander 6" - 8" Grinder
 5" - 8" Drill Press Mini Lathe
 8" Table Saw 10" - 12" Thickness Planer
 8" - 10" Bandsaw Scroll Saw
 Disc/Belt Sander Spindle/Belt Sander
 Mini Jointer
 Other _____
- Which portable/hand held power tools do you own? Check all that apply.
 Belt Sander Orbital Sander
 Biscuit Joiner Palm Sander
 Circular Saw Portable Planer
 Detail Sander Saber Saw
 Drill/Driver Reciprocating Saw
 Miter Saw Router
 Other _____
- What machines/supplies would you like to see?

- What new accessories would you like Woodstock International to carry?

- Do you think your purchase represents good value?
 Yes No
- Would you recommend Shop Fox® products to a friend?
 Yes No
- Comments: _____

FOLD ALONG DOTTED LINE

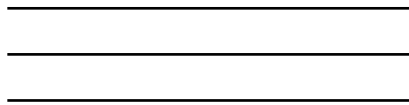

Place
Stamp
Here



WOODSTOCK INTERNATIONAL, INC.
P.O. BOX 2309
BELLINGHAM, WA 98227-2309



FOLD ALONG DOTTED LINE

TAPE ALONG EDGES--PLEASE DO NOT STAPLE