

# ***Wood Surfboard Kit Assembly Manual***

**Complete Instructions for all  
Wood Surfboard Supply®  
Surfboard Kits.**

Version 6 – January 2014



**Wood Surfboard Supply Inc.**

1424 South Ritchey St. # B

Santa Ana , CA 92705

Phone: (714) 834-9968

[WWW.WoodSurfboardSupply.com](http://WWW.WoodSurfboardSupply.com)

Copyrighted © 2009 - 2014. This material may not be duplicated in whole or part without the permission of Jack Young or Wood Surfboard Supply Inc.



# TABLE OF CONTENTS

<u>Title</u>	<u>Table of Contents</u>	<u>Page</u>
Table of Contents.....		2
Table of Contents (cont).....		3
Forward.....		4
A Word About Tools.....		4
Important – Read This! .....		4
Chapter 1 – The Work Area .....		5
Building Table .....		5
Required Tools and Equipment .....		5
Chapter 2 – Tools Needed .....		6
Chapter 3 – Materials .....		8
Other Materials Needed .....		8
Chapter 4 – Preparing the Wood.....		9
Saw the Wood Into Strips.....		9
Are Your Wood Strips Too Short?.....		9
Lay Out the Pattern.....		10
Wood Contrast Examples.....		10
Dry Bending the Wood With Gravity.....		11
Wet Bending the Wood.....		11
Chapter 5 – Frame Assembly .....		12
Unpacking .....		12
Export Kits.....		12
Fixing Tight Rib Slots .....		14
Attaching the Frame to the Building Table .....		15
Why Cut Notches in the Ribs? .....		18
Chapter 6 – Deck Planking .....		23
Planking .....		23
Attaching the Center Strip .....		24
Release the Board From the Table and Trim .....		30
Chapter 7 – Bottom Planking .....		32
Planking the Bottom .....		32
Chapter 8 – Rough Shaping .....		34
Chapter 9 – Rails .....		35
Hollow Strip Rails.....		38
Hollow Strip Rails on Square Rib Ends.....		39
Nose and Tail Blocks.....		40



# TABLE OF CONTENTS

<u>Title</u>	<u>Table of Contents (cont)</u>	<u>Page</u>
Chapter 10 – Sand and Seal .....		41
Rough Sanding .....		41
Finish Sanding .....		41
Sealing .....		41
Chapter 11 – Glassing and Finishing .....		42
Preparing to Glass the Board .....		42
Epoxy or Polyester? .....		42
Materials Needed .....		42
Summary of Glassing Steps.....		43
Resin Additives.....		44
How much Glass .....		45
Chapter 12 – Fin Box .....		48
Chapter 13 – Leash Cup .....		51
Chapter 14 – Vent .....		52

## List of Appendices

Appendix A – What Wood to Use .....	53
All About Wood .....	53
What Wood is Best? .....	53
Free Lumber .....	53
Appendix B – Wood Repairs .....	54
Invisible Repairs .....	54
Don't Use Wood Putty – Ever! .....	55
Appendix C – One-Piece Bottom .....	56
Appendix D – Modifying the Shape .....	58
Appendix E – Building the Fish .....	60
Appendix F – Export Kit Spar Assembly.....	65
Appendix G - Fin Location.....	67
Appendix H –Converting an SUP to a Windsurfer.....	68
Appendix I – Robert August “What I Ride” .....	70
Appendix J - Clearwater SUP .....	73
Appendix K - Links .....	76



## INTRODUCTION

### Forward

This manual contains the assembly instructions for all surfboard kits produced by Tucker Woodworking and sold by hollowbalsa.com. There are several different boards shown being constructed in this manual. This is because all models are built in essentially the same manner. Differences are noted where applicable. The pictures used in this manual were selected because they best illustrate the particular step.

There are several ways to accomplish almost any task. The procedures shown in this manual are tested and proven. You may know another way to perform a given procedure but try our way first. Once you have built your first board you will be anxious to build another and that's where you can experiment and personalize the process.

### A Word About Tools

The surfboards constructed from these kits are designed to be built with common woodworking tools and techniques. Certain special tools such as a power planer and jointer are helpful but not absolutely necessary. Other tools such as a good hand saw, long board sanding block, hand plane, and hot glue gun are essential. These tools will be noted where applicable.

### **IMPORTANT – READ THIS!**

During the years that it took to develop this kit, many different ways of securing the ribs and frame were tried. Likewise, many different ways of clamping the decking strips to the frame were used. ***The methods shown in this book have proven to be to be the easiest, cheapest, and most efficient ways found.***

The hot melt glue and scrap sticks used to temporarily mount the frame to the building board provide a strong, stable foundation and are easily removed when the frame is complete. The plastic wrapping film used to hold the deck strips snug while the glue cures is the best and simplest way found.

**Read through this entire book before you start the project. Make sure you understand what is being shown. Email questions or comments to:  
[jack@woodsrfboardsupply.com](mailto:jack@woodsrfboardsupply.com)**

## CHAPTER 1 – THE WORK AREA

### Building Table

The first thing to do is construct a good, solid working surface. Cut a piece of 5/8" (minimum) particle board (or other inexpensive wood) 24" wide and 8' long. If you are building a surfboard longer than 8', lengthen the table accordingly. Inexpensive wood is recommended to minimize costs. Construct a frame of 2 by 3's for stability. The table can now be supported on common sawhorses or you can add legs to achieve a comfortable working height. See the figure below for details.

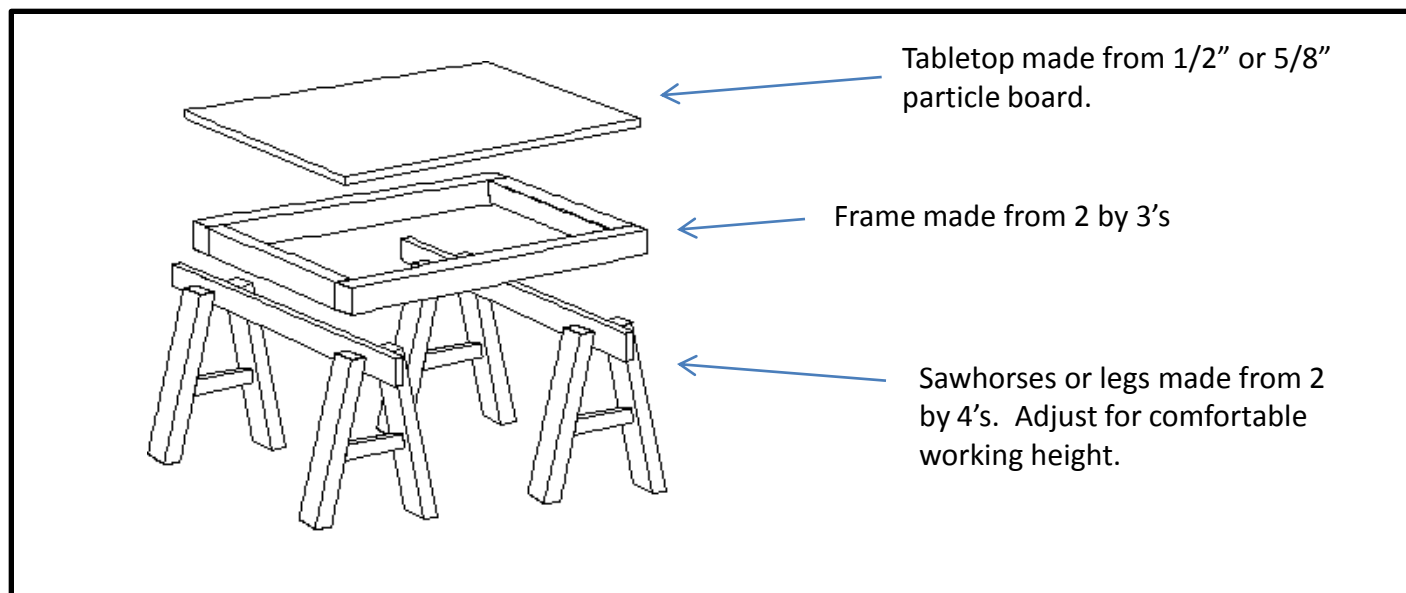

Typical Building Table

### Required Tools and Equipment

The following tools are required to complete your surfboard:

- Table saw
- Power or hand planer
- Hand saw (Japanese pull saw) or other fine blade saw
- Router (if you are going to mount a fin box)
- Long board sanding block
- Random orbital sander or equivalent finish sander
- Hammer and chisel
- Half dozen camp-type clothes pins
- Hot melt glue gun
- Roll of plastic wrapping film
- Disposable paint brushes (foam and bristle)

## CHAPTER 2 - TOOLS NEEDED



Actually there are few power tools considered absolutely necessary for this build. A table saw (or band saw) is probably the main one you will need. The wood needs to be sawn into strips – especially for the deck and rails - and a table saw (or band saw) is the best way to do it.

A band saw is good because the blade is very narrow. This results in a small “kerf”. Kerf is the width of the saw blade and also is wood wasted when you make a cut. Table saw blades are typically 1/8” thick while a band saw blade is about half that. Doesn’t sound like much but it adds up.



A belt sander can be used to shape the rails as well as for general sanding duties. This particular sander has dust collection and can be turned on its head to become a table type sander.



Finish sanders. Left is regular orbital sander and right is random orbital sander.



Hot glue gun used to apply frame holding sticks.

## CHAPTER 2 – TOOLS NEEDED



Hand planes and a long board sanding block. Using a hand plane creates much less mess than a belt sander.



You will need some 3, 4, and 5" sticks. These were cut from the scrap plywood the ribs came on. They can be made from any scrap wood.

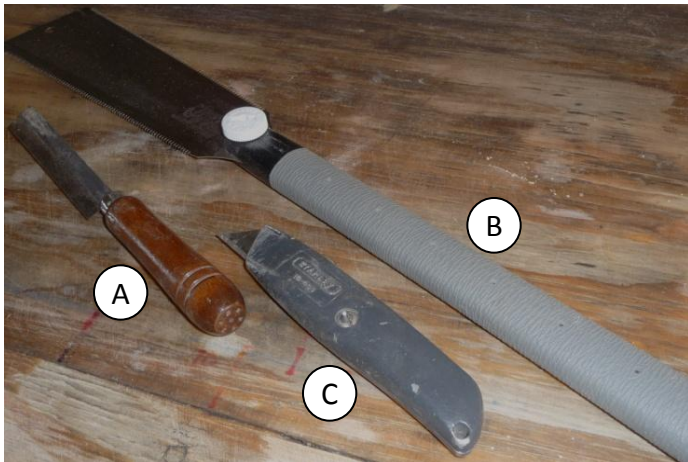

Common cutting tools include: A) Hobbyist saw, B) Japanese draw saw, and C) Utility knife.



Chalk line used to set center reference line.



Build a shaping stand using a cement foundation pier for a base (about \$6.00 at Home Depot). You can store it away when not in use.



Stretch plastic wrapping film from a moving supply or building materials store is used to hold the deck strips while the glue cures. It is incredibly strong when it is stretched out into a string

This roll came from Home Depot and cost under ten dollars. Probably has enough to do several boards.

# CHAPTER 3 – MATERIALS

## Other Materials Required

The following materials will be used to complete your surfboard:

- Wood glue
- Sandpaper
- Fiberglassing materials



Any quality waterproof wood glue will work. Epoxy is available in various drying times. Super glue and activator (right) greatly speed the framing process.

*If you can't find commercial activator common baking soda will work.*



Mixing cups, stirring sticks, and thinner for cleanup are required. The 16 oz. red party cups are perfect and much cheaper than the measuring cups.



Most epoxy resin sellers offer pumps that make mixing fool proof. They also make bubbles in the resin so be careful.

## CHAPTER 4 – PREPARING THE WOOD

### Saw the Wood Into Strips

Once you have selected the wood combination you will use for the board it is sawed into strips. Some builders are tempted to try using wide strips in order to shorten the glue-up time. Don't fall for this. Its hard to get the wood to bend two different directions at once (long ways with the rocker and sideways with the crown of the deck). The wider the strip the harder it is to make it bend both ways. You'll end up frustrated and with an uneven surface. Try to stay with strips under 1 ½ " wide. Under 1" is better.

### Are Your Wood Strips Too Short?

One thing many new builders don't realize is that the **wood strips don't have to be the full length of the surfboard**. If you are building a 12' SUP you are going to have a hard time finding 12 foot lumber. Its OK to make a joint – in fact they look nice! The pro's do it all the time. Whether you use a simple butt joint or a scarf joint just cut the wood clean, glue it properly, use a backing strip behind the joint.

#### Butt Joint (side view)

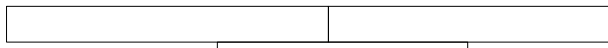

The simple butt joint is strong and easy to make. Always use a backing strip as shown for strength.

#### Scarf Joint (top view)

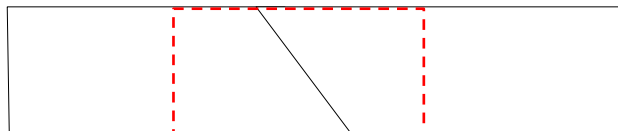

Backing strip shown as dashed line located (behind joint)

There are lots of other types of joints you could make if you have the time, experience and tools. They are nice but not at all necessary. The joints shown are simple, strong, and easy to make.

**Hint: stagger the joints instead of lining them up next to each other across the board. Putting the joints in a straight line will create a weak spot in the board.**



If you take your time and choose pieces of wood with similar grain your joints will be almost invisible. In this board no special selection was made. Pieces were selected simply because they were the right size. The differences in grain are obvious but the board still looks great. Nobody has ever commented about the joints, they just look natural.

This board is balsa and balsa grain is hard to match. Woods such as pine, paulownia and cedar are easier to match and the joints will be almost invisible. Just remember, wood is a natural product and variations are part of its personality.

# CHAPTER 4 – PREPARING THE WOOD

## Lay Out the Pattern

Once your wood is sawed into strips its time to lay it out. Spend some time here to get the best possible pattern. You'll start with the center strip and work out to each side. If you have contrasting strips try them in different combinations to find the one that looks best. If all the strips are not the same width its important to make sure that they match from side to side or the board will look lopsided. Also, if some of your boards are short, save them for the outside of the board where they don't have to be so long.

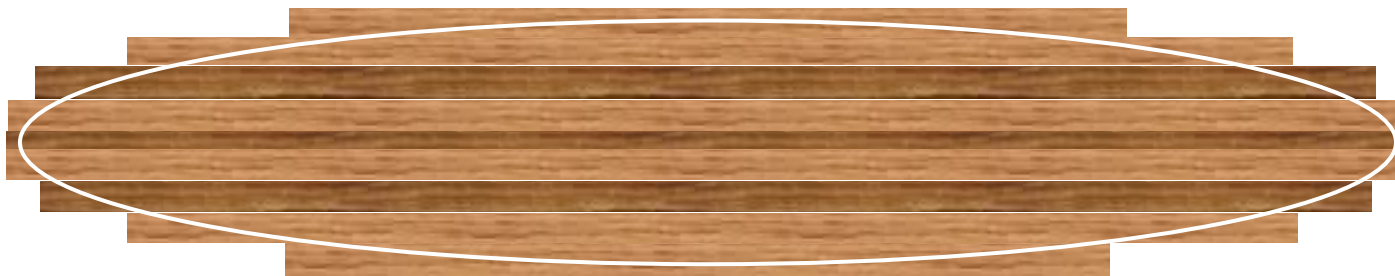

Patterns like the chevron shown below can be used to disguise joints. Getting the angled joints perfect takes time and patience though.

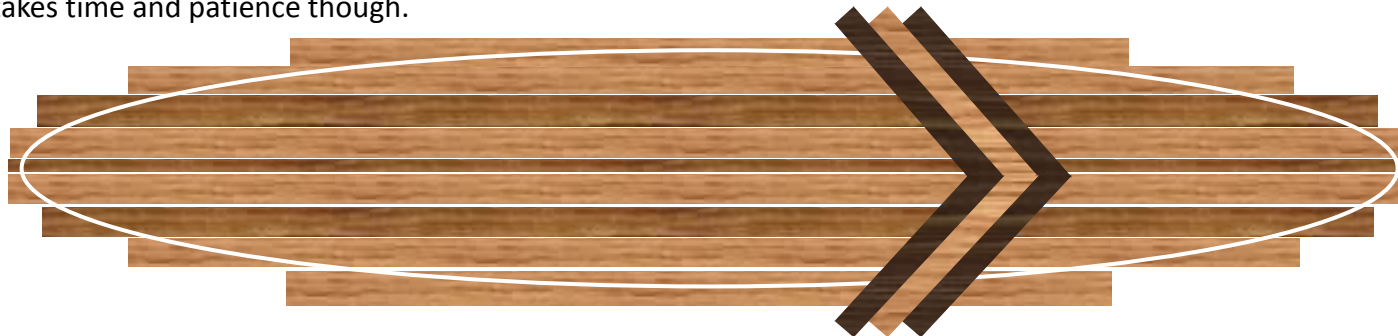

## Wood Contrast Examples



Mahogany with pine stringers balsa rails.



1/8" oak plywood (ply on bottom only)



Flamed maple, walnut, abalone



Paulownia & redwood balsa nose/rails



Pine & redwood



Balsa/Redwood (left)  
Hardwood shop scrap (right)

## CHAPTER 4 – PREPARING THE WOOD

### Dry Bending the Wood with Gravity

All wood that will be used for the surfboard deck planking should be pre bent. Skipping this step will almost certainly result in a board without the proper rocker. The wood will try to remain straight and will actually push the rocker out of the nose. You can also hang the wood on a rack so the bend is put in by gravity. This is illustrated in the picture below.



In the picture on the left the wood is wedged between a couple steps in a ladder and left alone for a few days. Gravity will slowly put a permanent bend in the wood. This method works best with hardwoods. In the picture on the right the bent piece of wood is shown on the frame. The curve looks like it's more than needed but it's perfect and will keep the rocker in the nose instead of trying to push the frame flat.

### Wet Bending the Wood

A plastic “kids play pool” is great for soaking wood prior to bending. Wood can release acids and oils that aren't good for a regular pool or spa. Just soak the wood long enough to soften the wood fibers and weight it similar to what is shown below. If you can't soak the wood in a pool you can lay it out as shown below and wet it with a hose several times. It will take a bend nicely. Just make sure its completely dry before using it.

#### **IMPORTANT!**

***Check each strip and decide which side will face the outside of the board and which side will be inside. The side that will be inside (glued to the frame) must be placed facing up as shown on the right! This way you will have the curve in the right direction and you won't have to worry if the strips change color as they sit in the sun.***



Let the wood sit for as long as needed. The pine and redwood strips on the right took a couple weeks to get a nice bend.

## CHAPTER 5 – FRAME ASSEMBLY

### Unpacking

The rib and spar are shipped in a custom package as shown below. Lay the package on the work table to open it. *Ribs shipped internationally are usually already cut out so the next few steps can be skipped.*

Carefully open the package by cutting the packing tape and removing the staples. It is recommended that you completely remove the staples from the cardboard to avoid injury.



Lay the ribs out on the table as shown below and inspect for damage



#### Note:

The kit pictured above is for a 10' 0" longboard. Due to its size, this kit requires two sheets to hold all the ribs and the spar. Other kits for shorter boards may contain a single sheet.

### Export Kits

If you have an export kit it will look like the kit on the right. The ribs and spar have been cut out in order to ship the kit internationally. Refer to Appendix F in the back of this book for detailed instructions on how to glue the spar together.



## CHAPTER 5 – FRAME ASSEMBLY



Use a sharp wood chisel to cut the tabs holding the ribs and spar in place. After all parts are cut, sand the edges smooth as shown below. Cut the outside inch of wood from the scrap using a table saw. These strips will be cut to 3" and 4" lengths to make the rib mounting sticks.



Locate the two spar pieces along with the gussets. Sand all the edges to ensure a precise fit. Remember, boards under 8' long won't have a gusset because the spar is in a single piece.



Place a straight edge along the top edge of the spar to ensure proper alignment. Glue the gussets to each side of the spar. Place a weight over the joint and allow to dry.

## CHAPTER 5 – FRAME ASSEMBLY

### Fixing Tight Rib Slots

Plywood is a natural material and is subject to variations in thickness, weight, color, density, and more. Even though your surfboard kit was cut on a computer controlled machine to very precise tolerances, variations in wood thickness can cause the ribs to be too thick for the slot. The ribs should slide into their mating slot with slight resistance. Trial fit the pieces by slipping the mating slots together. 99% of the time it will be a good, snug fit. If, however, the fit is extremely tight, don't force the pieces together. Perform the following steps on each slot.



Cut a piece of 80 grit sand paper into  $\frac{1}{4}$  sheet pieces. Use a piece of 1" square wood to use as a backing.



Wrap the sandpaper around the wood backing as shown. Make sure the corners are tight and sharp



Lightly sand a bevel into the sides of each slot as shown. You are NOT making the slot bigger, you are simply beveling each edge so the pieces will slip together.

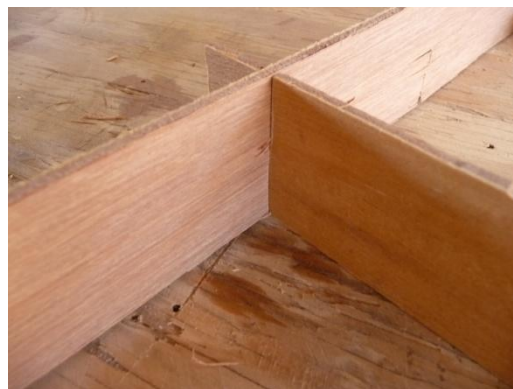

Repeat this procedure on all slots and trial fit each piece. Remember, the idea is not to enlarge the slot, it is to bevel the edges so they will slide together.

***Avoid the temptation to use power tools to open up a tight slot. Sanding the bevels into the edges of the slots as shown above will allow the pieces to fit together without changing the rib center. This process will produce a very strong, proper fitting joint on each rib.***

## CHAPTER 5 – FRAME ASSEMBLY

### Attaching the Frame to the Building Table

The frame and ribs are temporarily glued to the building board using a hot melt glue gun. Usually two sticks per rib and about 10 for the spar will be needed. Cut the sticks from the scrap plywood that held the ribs and spar or make them from other scrap wood. Popsicle sticks from a craft store work well too.



Snap a chalk line in the center of the building table.



Cut scrap strips into pieces 3", 4", and 5". Make at least 2 for each rib and 10 for the spar.



Hot glue a stick against (but not on) the chalk line and check with a square to ensure it is not tilted either toward or away from the line.



Continue down the center line adding a stick every 8 to 10 inches. Check that each stick is square as shown.

**The spar will be attached to these sticks during the building process so if they are not square, the spar will not be square and that means you will build a twist or warp into your board.**

## CHAPTER 5 – FRAME ASSEMBLY

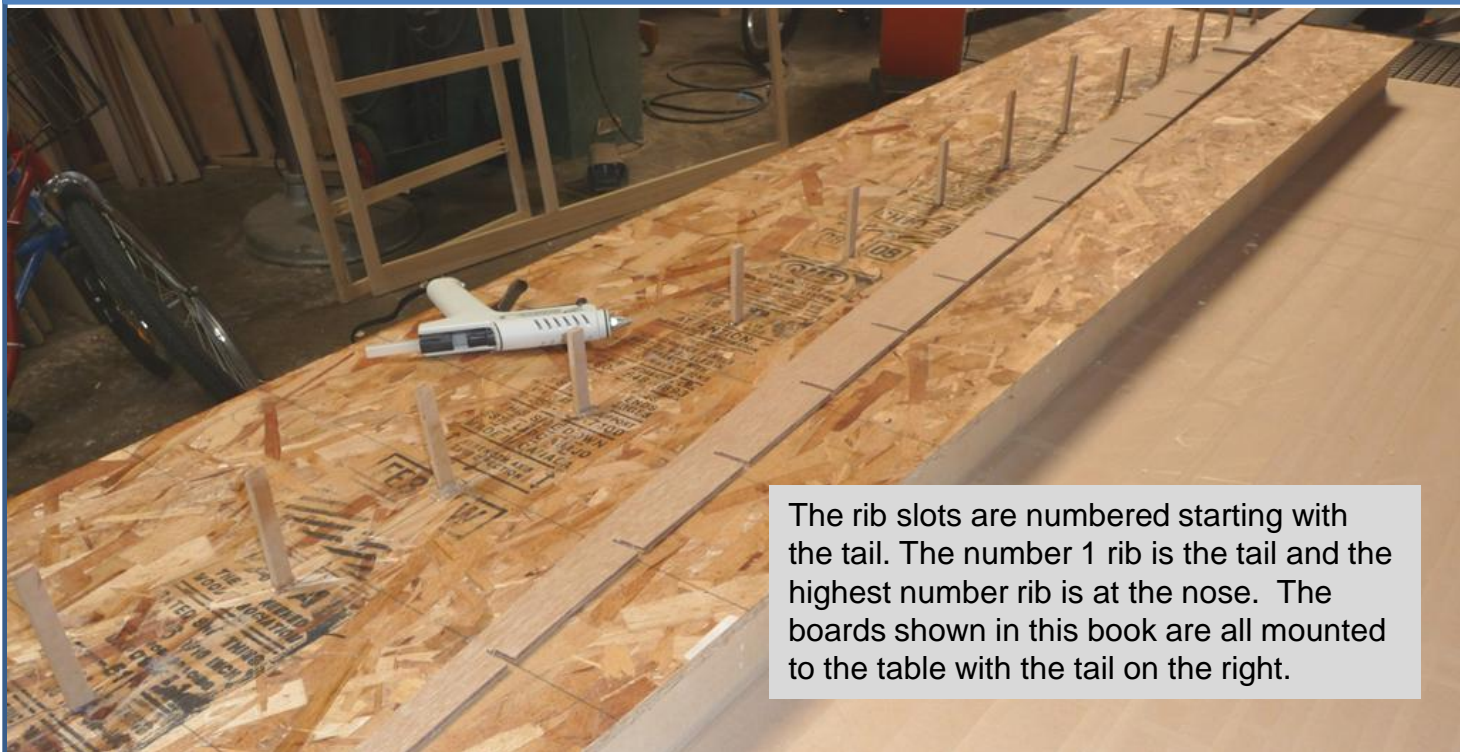

Once all the mounting sticks are glued in place and the hot glue has cured the main spar can be attached to the sticks. **The spar will be mounted about four inches above the building table** to provide access under the board. The reason this access is needed will become clear in a few steps.

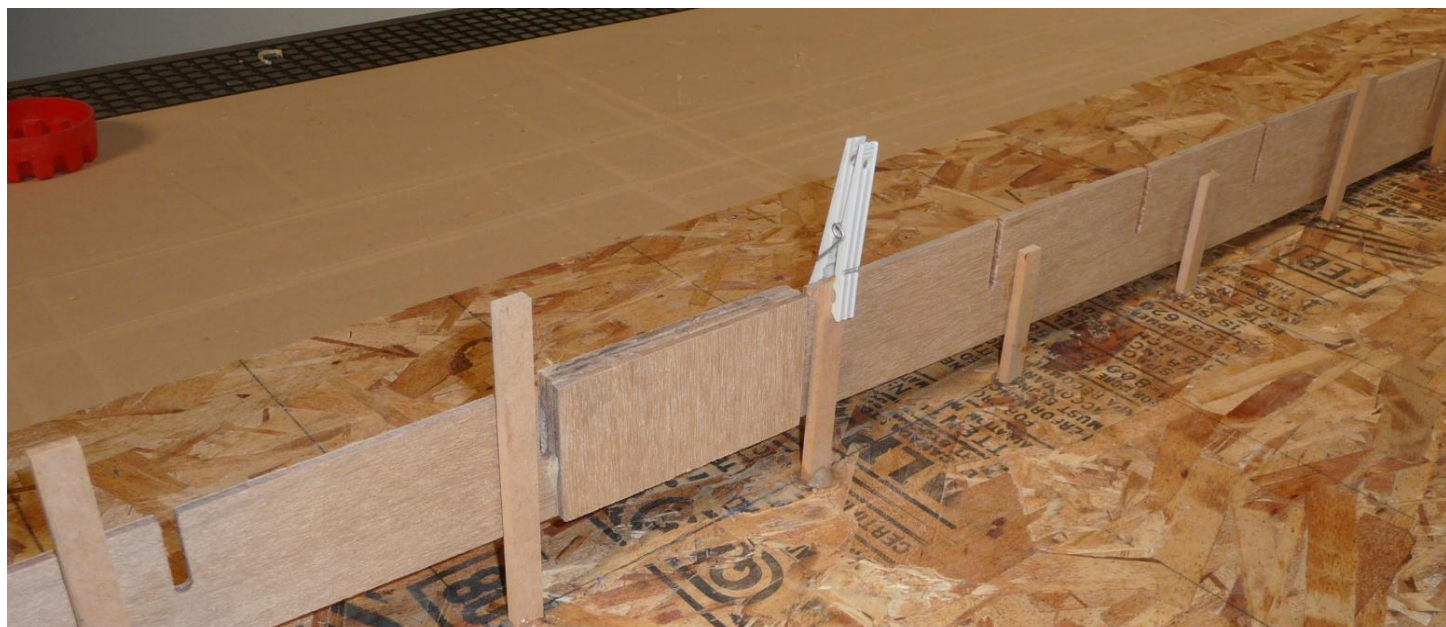

## CHAPTER 5 – FRAME ASSEMBLY

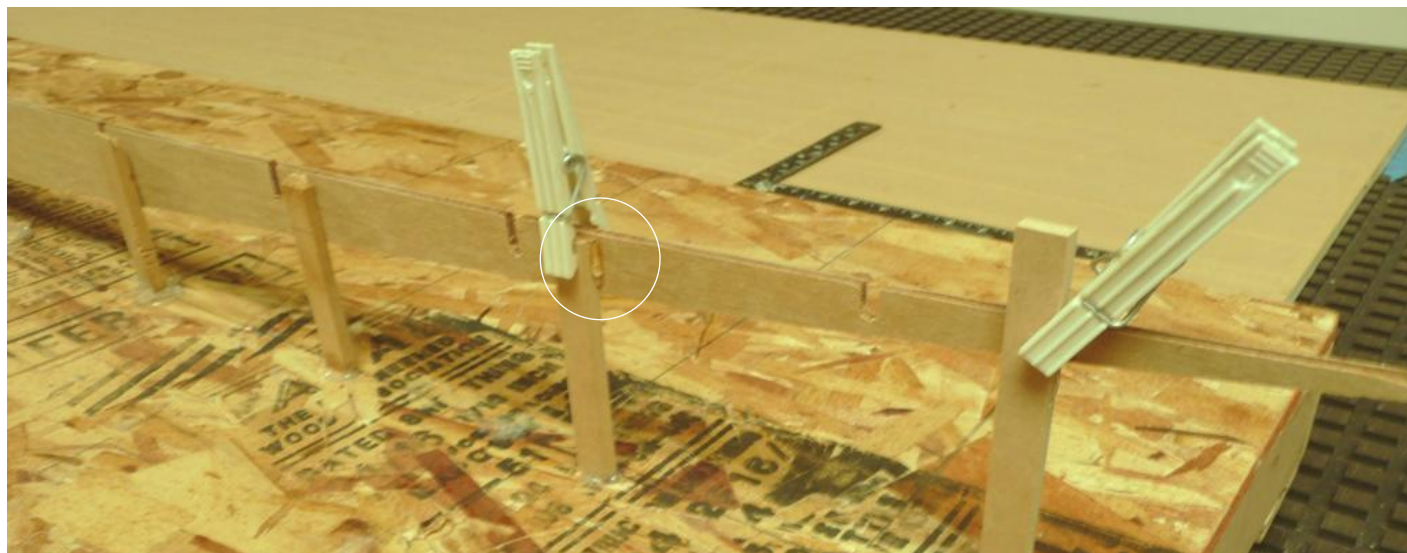

While the spar is held snugly against the stick, apply a bead of hot melt glue as shown. This stick will be removed later so don't use more than about a 1-inch bead.



Glue each stick the same way. Apply a 1" bead of glue and move the clothes pin from the previous stick to hold it while it hardens. Using this method, the entire spar can be mounted quickly with only a couple clothes pins. Use the square to double check that the spar is exactly perpendicular to the table and directly above the chalk line.

## CHAPTER 5 – FRAME ASSEMBLY

### Why Cut Notches in the Ribs?

After building hollow wooden surfboards for many years I finally had one leak. The leak was my fault since I installed the removable fin boxes incorrectly. The water was in the tail and without thinking I turned the board upside down to drain the water to the nose where it could exit through the vent hole. Problem is there was no drain path for the water. It had to work its way slowly from the tail to the nose through any small gaps it could find in the ribs and rails. As a result the beautiful wood strips on the bottom all warped and I now have a board with channels in the bottom. Too bad they are random and not placed where they would add performance to the board. Now when I build I cut notches in the ribs like shown below.

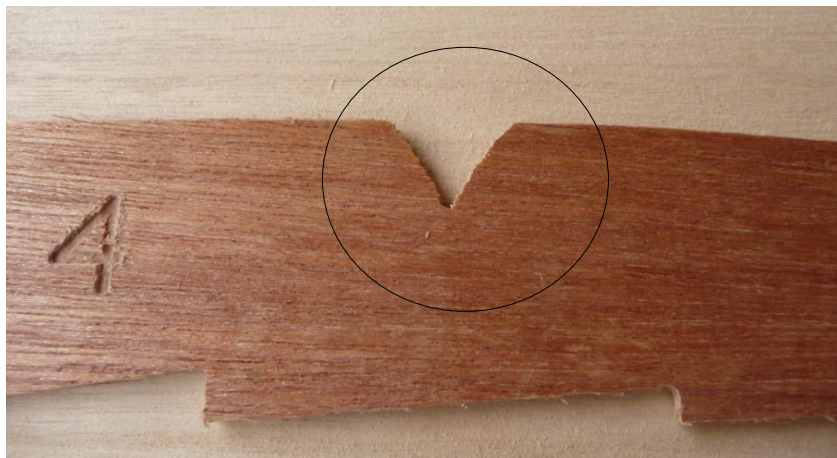

This is a rib for “The Toad” You can see that the bottom profile of this board is very different from a flat bottom board. But it’s the top edge that we are interested in. I cut a “V” notch in the top of each rib to allow water to drain to the nose where it can exit via the vent hole. Of course the best thing is to never get water inside your board - but it can happen.

Here are the notches of a board after the deck is complete. They provide a drain path for water. If you cut notches do them on both sides of the spar so there will be two per rib. Cut the notches one at a time and don’t make them in a straight line down the length of the board. I place them close to the spar so I know where they are if I need to run water down.

This picture shows gluing strips installed on one side of the ribs. Putting them on both sides is tedious but worth the effort.



## CHAPTER 5 – FRAME ASSEMBLY

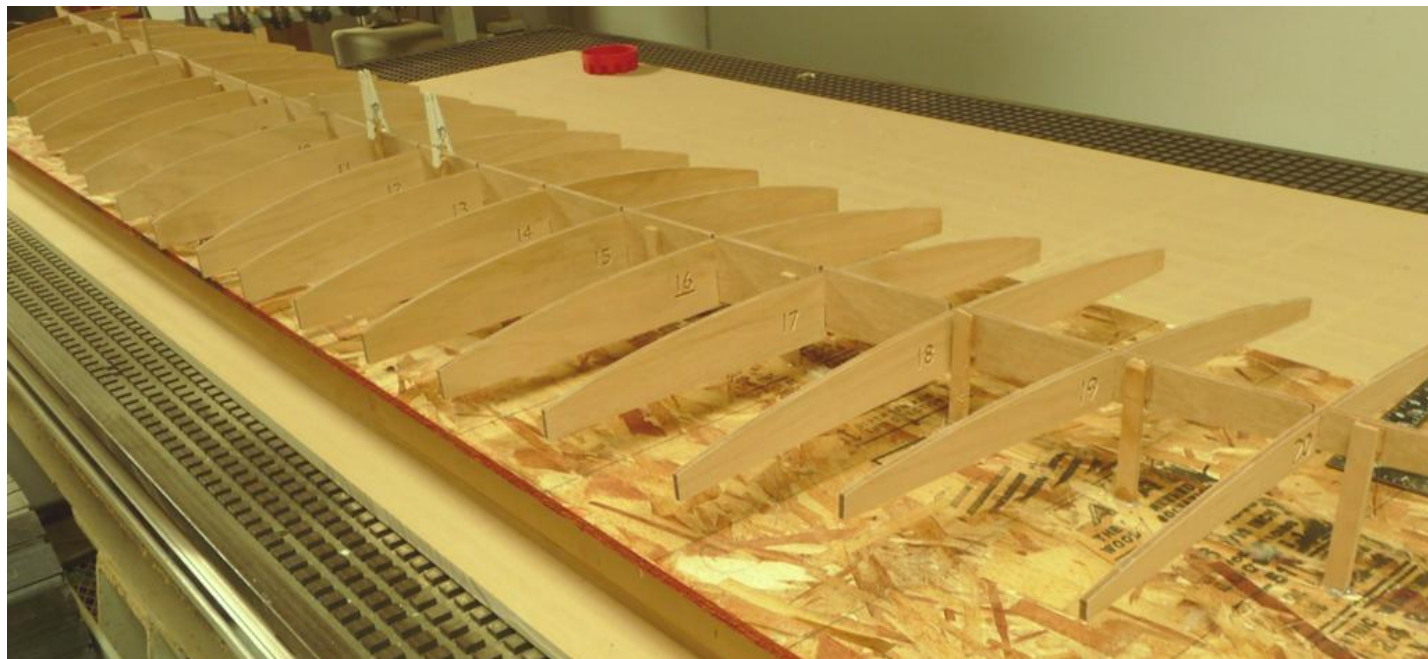

Now all the numbered ribs can be installed into the corresponding numbered slot in the spar. The ribs are left floating at this point so don't put any glue in the slots yet. The ribs can be glued after they are leveled in the following steps. They can also be left "floating" and glued from below after the deck is installed.



Starting at one end of the frame, level the rib and make sure it is exactly perpendicular to the spar. Sticks (like those used to mount the spar) will now be glued to each rib to hold it square and true. Take your time on each rib. All the ribs must be perfect before the planking can be applied. Check each rib with a square and a level. Also, sight down the length of the frame often to make sure the alignment is perfect.

## CHAPTER 5 – FRAME ASSEMBLY



Here are a couple inexpensive tools you can make to ensure you get the ribs mounted square. You need to cut two exact  $90^\circ$  triangles as shown. Use an accurate miter saw or box to get an exact cut. Mount one on top of a short piece of wood so that it will be in about the center of the rib and spar. Use the tools as shown to ensure that every rib is straight and square.



Make a mark on a scrap piece of wood at the top edge of the rib as shown on the left. Now check the other end of the same rib as shown on the right. The height should be exactly the same. Adjust as required. Repeat this step on *every* rib.

## CHAPTER 5 – FRAME ASSEMBLY



Once you are sure the rib is square and level, use a clothespin to hold one of the scrap sticks tight against the rib and snug to the mounting table.



Now you can apply a nice bead of hot glue to hold the stick to the rib. Apply a healthy bead of glue to the stick where it touches the mounting table.



Stand back and sight down the length of the skeleton. All the ribs should look straight and even. Once the frame is perfect you can drop a spot of glue in each rib slot.



Sometimes a rib may have some slight twist to it, especially if it's really humid. The rib can be straightened using braces as shown above.

## CHAPTER 5 – FRAME ASSEMBLY



The rail strips are put on now. They are glued on using instant glue and accelerator. You can use regular glue but it will take forever. If you can't find CA glue accelerator you can use regular baking soda. Just dust the glue joint with soda when the glue is still wet and it will harden instantly.



The instant glue is applied to the joint and given a squirt of accelerator. The glue sets instantly leaving some residue as shown. Once both rail strips are on, a bead of wood glue will be added to the back of each joint for strength.



The rail strips only need to be attached to rib ends. They don't need to extend past the first or last rib. They are used to hold the rib ends in place as the top and bottom are planked. They are not a structural part of the finished board.

After the top and bottom rail strips are installed, double check that all the ribs are all still square and even. The rail strips will define the outer contour of the board and will serve as a sanding guide when the deck and bottom planks are installed. They also keep the ribs from curling with humidity changes.

## CHAPTER 6 – DECK PLANKING

### Planking

**Planking the deck is an important step and should not be rushed.** Both the strength and beauty of the finished board depend on the decking being applied properly. The deck is always applied as individual planks because of the compound curves. The bottom, however, is flat and can be planked using a single sheet if desired.



**The surfboard in this picture was made using planks no more than 3" wide.** The wood is carefully selected to match the color and grain of the adjoining plank and that gives the illusion of an almost solid piece. The deck planks must bend in two directions to follow the rocker of the board in one direction and the dome of the ribs in the other direction. It is very difficult to force wide sheets of wood do this. The answer is to use individual narrow planks.

**Special joinery such as cove and bead is not really necessary.** Even though the deck is domed, tapered edges on the deck planks are not required. The picture on the right is a close up of the deck made from planks with square edges. The planks were simply run through a table saw using a finish blade to get perfect gluing edges. If a power planer is available, run the strips through on edge one at a time.

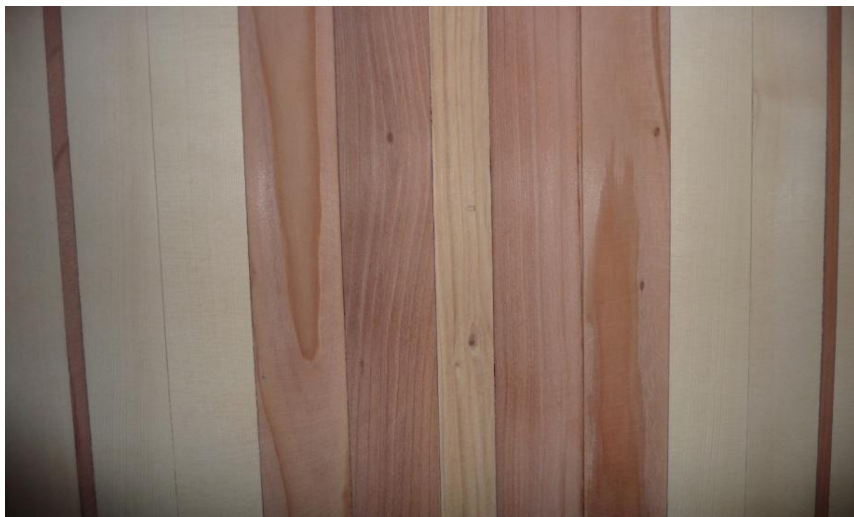

**The wood thickness depends on the type of wood being used.** Hard wood can be as thin as 3/16" while softer woods such as pine, cedar, or redwood should be 1/4" to 5/16" thick. **Avoid placing hard woods and soft woods next to each other.** When the deck is sanded the soft woods will sand away easily and the hard woods will resist the abrasion and remain proud. The result can be cupping of the softer woods and an uneven surface.

**Never try to add all the deck strips at once.** Depending on the cure time of the glue being used, figure on adding about 6 strips a day: *2 in the morning, 2 at lunchtime, and 2 in the evening.* Double check the directions on the glue container. Using fast-curing glues such as 1-hour epoxy can shorten the cure time but be sure to follow the manufacturers recommendations. **Be especially careful in cold climates since cure times typically are much longer with lower temperatures.**

## CHAPTER 6 – DECK PLANKING

### Attaching the Center Strip

This is the center plank that will be glued over the main spar of the board. It is shown being “pre curved” prior to gluing. Pre curving puts a nice curve in the wood so it won’t work against the rocker of the board when its installed. As a minimum, the center deck plank and the first two planks on each side of it should be pre bent. Drape the planks as shown to the left and leave them there overnight. Gravity will do the work. As a result, the timber will take a nice gentle curve that will work *with* the rocker instead of *against* it.

The center deck plank is now fitted. The center plank should be no more than one inch wide.

Notice the pre bent plank has too much curve. That’s OK, it will glue nicely.



Rather than using cumbersome clamps to secure the planks while the glue dries, a system was devised that uses common plastic wrapping film. When used as shown the film holds great and is cheap.



Plastic wrapping film comes in a roll and is available at moving supply stores or in many home improvement stores like Home Depot. Pull about a 3-foot piece and tear it from the roll.



While holding one end, grab about 1/3 of the piece and stretch it to double the original length. Leave the other 2/3 un-stretched for now. The string that you just created will be tied to the ribs in the following steps.

## CHAPTER 6 – DECK PLANKING

1. Count the ribs and make a plastic string for half the ribs as previously described.
2. Starting at the nose, tie the string around one of the end ribs approximately 6" out from the main spar.
3. Repeat this on **every other rib**.
4. Leave the un stretched ends of the strapping film hanging toward the outside rail so they are out of the way during the next steps.
5. After a string is tied to every other rib, the center strip can be glued in place.



### Note

*The first plank applied is the center strip and its placement is critical! If it is not centered it will throw off the symmetry of the board. Once the center strip is in place, planks are added two at a time. The two strips added each time must be exactly the same width or the board will look unbalanced.*



6. Apply a thin bead of glue to the top of the main spar and ribs. Be careful not to put more glue than necessary to hold the first strip or it will need to be cleaned off before the successive planks are added.
7. Set the center strip in place and triple check that it is perfectly straight.
8. Beginning at one end, take the un-stretched part of the strapping film and stretch it out like you did before. Now you can use the string you just created to tie the plank to the spar as. **By stretching the film just before tying it you create a string that shrinks slightly and gets tighter after it is tied in place.**

## CHAPTER 6 – DECK PLANKING



The strapping film, when stretched, is long enough to secure the plank across two ribs. No special knots are needed on the end since the plastic will stick to itself. Simply tuck the end under a strand as shown and it will stay in place.



While waiting for the center plank to dry, you can glue 1/4" square sticks to the top edge of each rib. **These sticks are important. They increase the gluing surface and will help minimize warping if water ever gets inside the board.** You can use balsa if available or scrap redwood as shown. The block must accurately follow the curve of the rib so it is necessary to make it in several pieces. The strips are applied to the side of the rib at the top edge not on the top of the rib.

## CHAPTER 6 – DECK PLANKING



Cut and remove all the strapping film that was used to install the frame center strip.

Clean any excess glue from the tops of the ribs and the sides of the center plank to ensure that the successive planks fit snugly.

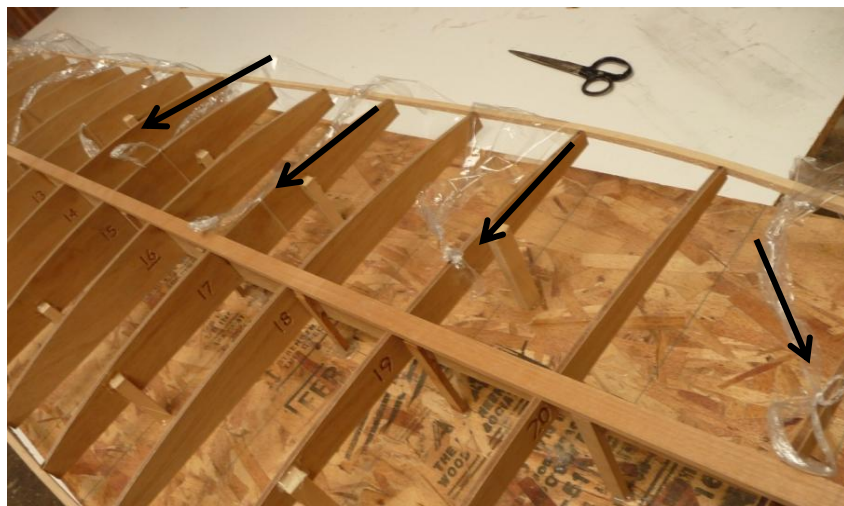

Now you need to add more plastic wrapping film just like was done earlier for the center strip (see arrows on right). Pre-stretch the film and tie it around *every other rib* a couple inches out from the center strip.

## CHAPTER 6 – DECK PLANKING



Apply a thin bead of glue to each side of the center strip and to the top of each rib. Again, be careful not to apply a bead wider than the strip being installed.

### Note

As previously noted, a  $\frac{1}{4}$ " square wood strip should be glued to at least one side of each rib flush with the top and bottom edges to provide additional gluing surface. Installing the strips on both sides of the rib is best. The blocks are essential to produce a strong bond between the ribs and decking. This increased bond can prove useful if water ever gets inside the board because it will help prevent the decking boards from warping.

### Note

The rail strips stop at the first and last rib. They do not need to extend into the nose or tail area.

Use the plastic wrapping film to hold the planks together. You are binding the wood so that all the strips are tight against the ribs as well as tight against each other. **Pull it tight to eliminate gaps!**



## CHAPTER 6 – DECK PLANKING



Here is why you should pre bend the wood strips. The two outside boards are flat and will actually push the rocker out of the nose.



Boards with a lot of nose rocker will benefit from a block under the end of the deck strips to keep the curve until the glue dries. Using pre bent wood helps!



A clamp may be needed to hold the boards tight until the glue dries. For the rest of the board the plastic string is strong enough to hold the boards together and tight against the ribs while the glue dries.



Wrap the plastic string around the ribs in a zig-zag pattern. Don't be afraid to pull it tight. The tighter you pull, the better the glue joints will be.

Notice the ends of the strings in the picture on the left. They aren't knotted or tied, they are simply tucker under one of the strings and maybe looped once or twice. They will hold because of the way the plastic clings.



## CHAPTER 6 – DECK PLANKING



You have to get more creative in tying the plastic as you get close to the rails. A clamp can help or drywall screws that are screwed into the building table can provide a post that you can wrap the string around. Here the deck strips are all glued and ready to have the strapping tape removed.



### Release Board from Building Table and Trim

Once the deck planking is completely finished the board can be removed from the building table. Reach under the surfboard and simply break the sticks from the table and ribs. Some sticks will break in the process, save any that don't for your next board. Use a hand saw to cut any stubborn sticks. Once the surfboard is free from the table turn it over. The structure is quite rigid at this point and the edges can be trimmed. Also, break off any sticks attached to the ribs and spar. This is where it is easy to see why it is advised not to use excess glue when mounting the sticks.

## CHAPTER 7 – BOTTOM PLANKING



The structure is now quite rigid and no special jigs are needed to hold it while the bottom is planked. Set the board upside down on a couple wood blocks or a thick movers quilt so the nose and tail don't touch the table. This will provide sufficient support for the planking operation.



If a fin box is to be installed, balsa blocks are glued on both sides of the spar. Installing long blocks as shown will eliminate the hassle of trying to find the blocks when the fin box hole is routed. If multiple fins will be used, install additional blocks where required. Install a block in the nose for the vent too.



Once the bottom is securely glued on it is recommended that 2" fiberglass tape be installed as shown. If you don't have the tape strips you can cut strips from a large piece of fiberglass cloth.

The strips lap 1" up every rib and 1" along the deck. This provides maximum protection against the deck planks ever coming loose from the ribs



Brush epoxy resin onto the glass tape and shown. Only apply enough to wet out the cloth. Don't let it puddle up because you will just add weight without adding strength. Once the glass strips are dry coat the inside of the board with a mixture of 75% epoxy resin thinned with 25% Denatured Alcohol. **Check to see if the glass has covered any of the V notches you cut in the ribs (see page 18). Open the notches up if necessary.**

## CHAPTER 7 – BOTTOM PLANKING

### Planking the Bottom

Planking the bottom is basically the same as planking the deck except the plastic strapping tape is not used to clamp the wood strips. Instead, weights such as concrete blocks or exercise weights (or anything else heavy that you have within reach) are used to hold the strips until the glue cures.



Apply a small bead of glue to the spar and center the first plank in the exact center. Clamp the plank into position as shown.



Now clamp the nose the same way the tail was using caution to ensure the plank is perfectly centered over the spar.



Hold the center strip in position with weights until the glue cures. You can use anything within reach that is heavy. Concrete blocks work too.

Planking the bottom of a multi-channel board is different from a board with a flat bottom. Two wood strips exactly the same width and thickness are applied at once. The edges of the planks on this board must be beveled slightly at the rear because of the “V” bottom.

Note the excess gorilla glue foam on the ribs. This is what happens when you glue the deck planks directly to the ribs without putting a gluing strip as shown earlier.



## CHAPTER 7 – BOTTOM PLANKING

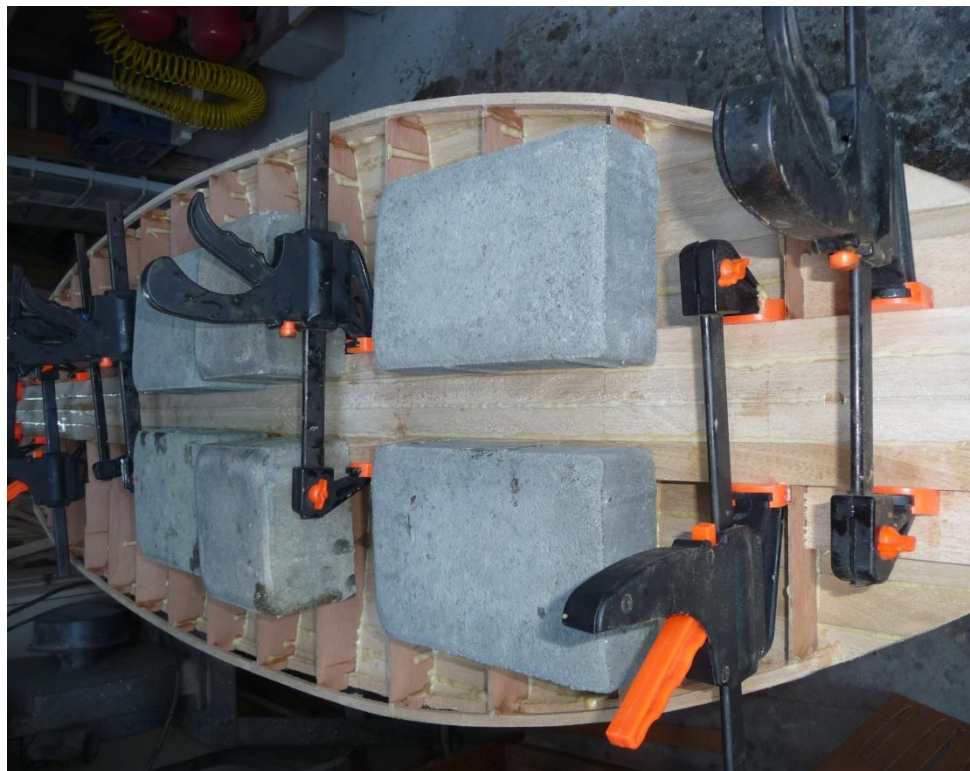

As the planking strips are installed they need to be clamped together to make a tight joint as well as being weighted down to make good contact with the ribs.

A dozen or so concrete pavers are a good investment. They are heavy enough to make a good glue joint and are inexpensive.

As more planks are installed you will need wider clamps. If you don't have clamps you can use additional blocks sitting on the ribs to push the wood strips together.

As the decking is installed, keep the structure as level as possible. It is possible to introduce a slight twist into the board at this point. If the frame is twisted and you glue a plank in place the board will hold the twist.

You can use a level as shown to make sure the frame is straight and true. Notice that there is an extra weight on the left side of the board to compensate for the weight of the clamps that overhang on the right side.

If you notice that there is a twist in your board you can use weights to deliberately twist the frame back into square while the glue dries.



## CHAPTER 8 – ROUGH SHAPING



Once the bottom planking is installed, use a saber saw or hand saw to trim the bottom planking. Stay approximately 1/8" out from the rail strips.



Here is the fully planked board with the deck and bottom rough cut to final shape.



A power plane set to the **minimum depth cut possible** is used to start final shaping. Don't cut into the balsa rail strips. If a power plane is not available a regular block plane will work fine. If shaping stands are available you will be able to set the board on its side and see better.



The final sanding is done with the long board sanding block and 36 grit sand paper. If you don't have a long board sanding block you can use a full sheet of sand paper wrapped around a block of wood. Don't sand these rails without using a block or you will end up with uneven lines.

## CHAPTER 9 – RAILS

The rails are built up of layers of balsa or other soft wood. The strips should be cut to about 3/16" thick and no more than 1/4" thick. Depending on the thickness it can take as many as five layers to build up the rails. Build up the rails to about 1 1/4 to 1 1/2" thick. This thickness will allow you to shape any rail profile.



Lay the rails up one layer at a time. Using instant glue and accelerator will greatly speed the process. The strips get to a point where they will break before breaking any more. At this point a solid block needs to be cut and fitted.



End the rail planks at a convenient point and cut a solid piece of wood to complete the nose block. This shows the completed nose block. Depending on the style, the nose block could be wider or made up of laminations of contrasting wood.



The tail has a gentle enough curve to allow the balsa to bend without breaking. Run the strips right to the tail. This will then be cut square and a tail block added.



A shaping stand allows the board to be turned on its side so the rail laminations can be installed using a combination of weights and clamps.

## CHAPTER 9 – RAILS



Stand back and look at the board to make sure the rail curves are correct. Trust your eye but measure from center to rail if it doesn't look even.

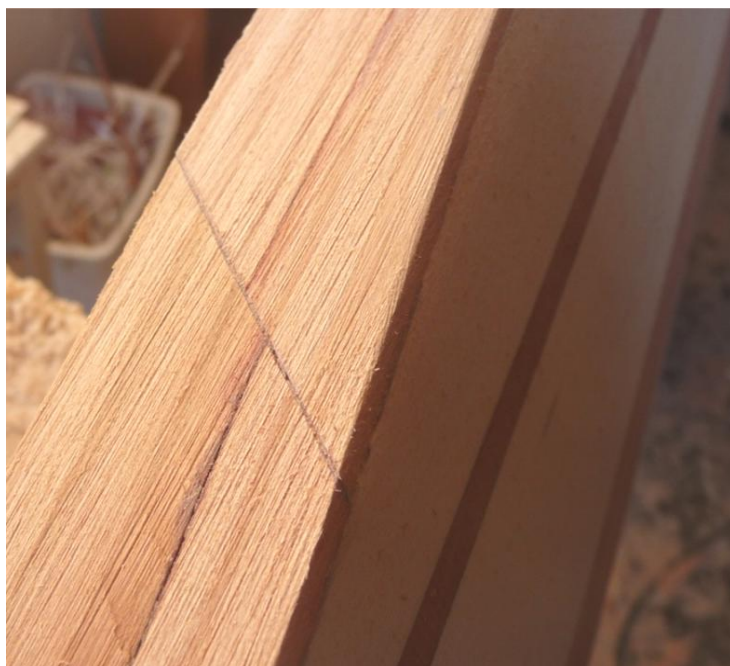

On this board a 1/8" redwood strip was put as the first layer and will be followed with light balsa. This will make a pin line in the finished board. Make joints as shown for best strength.



The gradual curve on this board didn't require a solid nose block to be made so it can be built up in layers. Keep the strips thin enough to bend without breaking. Compare this nose to the solid nose block shown on page 40.



The rails are built up to about 1 1/2" thick and start out very square. Shaping is done using a block plane and long sanding block. A belt sander can be used but they are messy and dangerous. Go slow and check often. Make sure the rails are identical on both sides of the board.

## CHAPTER 9 – RAILS



Here is an alternative way of applying dark wood to form a pin line. Any wood harder than the balsa will work. Cut the wood into strips and glue them side-by-side as shown.



You don't have to worry about bending the wood around the curve of the board. Plus the end grain line it creates is a nice look.



This is why its good to install a thin, solid board to be a pin line. In addition to looking nice, it gives a solid base to screw into when installing the balsa rails. Spread the glue on the wood and use deck screws and a small piece of wood to hold the rail strip securely while the glue dries. Stay in the center of the rail so that the screw holes don't show when the rails are shaped.



Use a combination of screws, clamps and weights to hold the rail strips while the glue dries. If you don't have long clamps, concrete blocks are inexpensive and work well as weights. The idea is to keep adding weights and screws until the rail strip being applied it snug to the layer below it with no gap. This picture shows why a shaping stand is good to have. You can turn the board on its side to work on the rails.

## CHAPTER 9 – RAILS

### Hollow Strip Rails

Some of the kits sold by Wood Surfboard Supply offer the builder the option of making the solid laid up rails as previously described or hollow strip rails. The strip rails are preferred by some builders but take a fair amount of work and expertise to build. Refer to the following pictures for a description.



The advantage of making the hollow strip rails is the rib ends have the exact rail profile built-in so there is no guessing whether you got the rail shape right or not. The disadvantage is that they require a fair amount of cutting and fitting many individual strips. If you aren't sure which method is best for you we suggest you cut off the rib ends at the cut line and make solid rails.

This Robert August “What I Ride” shown here is being built with hollow strip rails. The ribs for this model have been made so that when  $\frac{1}{4}$ ” square strips are glued to the outside they duplicate the exact rail profile as a factory WIR board. In this method full length  $\frac{1}{4}$ ” strips are glued to the top and bottom of the rib as shown. The rails are completed by cutting and fitting individual strips around the perimeter of the rib ends. Each strip will be fitted to make clean, tight joints at the nose and tail.



Note that holes have been drilled in each rib. These holes are optional and are not for weight reduction, rather they are to allow water to be removed in the event of a leak. Any water that gets inside the board can be allowed to run to the nose where it can be drained through the vent hole. Air can then be circulated through the structure to dry the interior.



$\frac{1}{4}$ ” square strips are glued around the rail ends to make the hollow strip rails. The strips can be either milled square, angled, or cut with a “bead and cove” depending on the builder’s equipment and level of expertise. If you aren’t familiar with these techniques or don’t have the required equipment, cut the ribs off at the score line and make the solid laid up rails described earlier in this chapter.

## CHAPTER 9 – RAILS (CONT)

### Hollow Strip Rails On Square Rib Ends

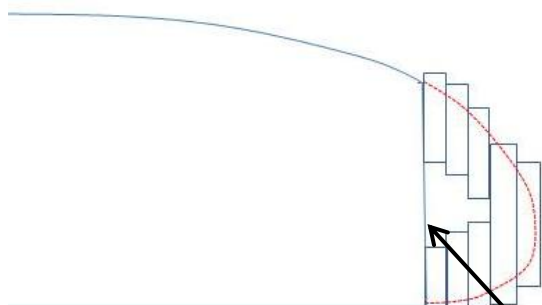

Here are some alternate rail construction methods you can try. Instead of laying up solid boards you can use strips glued so that they overlap each other. This method requires careful planning so that the minimum amount of wood is used to save weight but there is enough to shape the rails after you finish.

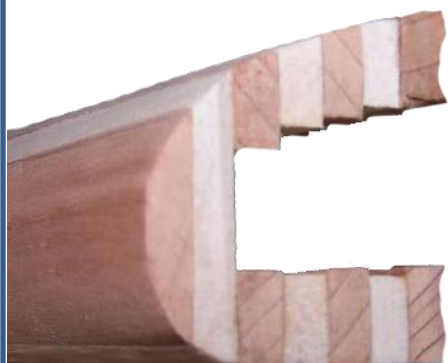

Rib with square end

This is a cut away of a rail section showing alternating light and dark woods. It gives a really nice finished appearance.

Note that the boards on the bottom are pretty much straight across. This will allow you to shape a nice hard (flat on the bottom) rail in the rear of the board but there is enough wood to transition to softer (rounder) rails in the front of the board.



The rails on this SUP are large and required a lot of shaping. Note the shavings on the table. A simple block plane was used to shape these rails. It is faster, quieter, and far less messy than a power sander. These rails are strong and weigh about half what solid rails would weigh. That's important on a 12' Stand Up Paddleboard.

#### NOTE

There are literally dozens of different ways to lay up rails. These examples are some that we have used and, no doubt, you will be able come up with others. Let your creativity go wild.

## CHAPTER 9 – RAILS

### Nose and Tail Blocks

Many first-time builders get stressed about where to end the rail strips and how to get the nose and tail perfect. The pictures on this page show the nose and tail blocks being installed on an 8' 0" Mini Mal. Because of the size of the blocks used the board actually turned out to be 8' 4".

Make a paper template and cut it until you get the shape you desire. This shows the board being cut off in a "V" shape but a rounded block cut to the contour of the board could have been used instead.



This board will get a simple nose block made from 1 ½" square balsa. The rails strips and nose are cut to the shape of the nose block



A couple long clamps are used to hold the nose block in place while the glue dries.



The nose is then planed and sanded to the desired shape. Make a paper template to be safe.



The tail block is made from the same balsa stock as the nose block. Finish sand with a longboard sanding block only to get the perfect flow into the rails.

## CHAPTER 10 – SAND AND SEAL

### Rough Sanding

Rough sanding gets rid of the high spots as well as any glue beads. It is best done using either a power plane or a manual block plane as shown. A belt sander can also be used.

A plane is always your best bet because they are quiet, efficient, and don't fill the area with dust.

Plane or rough sand the boards even enough to provide a good starting point for the finish sanding.



### Finish Sanding

Finish sand the board using the long board sanding block. An improperly sanded board will have high and low spots that will be especially noticeable after the board is glassed. Start sanding using 80 grit paper and gradually move to at least 220 grit to ensure that all scratches and gouges are removed.

Start sanding rail-to-rail slowly moving the entire length of the board. Repeat this process on both sides of the board. Now use the block to sand the length of the board from nose to tail.

### Sealing

Sealing simply consists of painting a coat of epoxy resin onto the wood before glassing. This coat is sometimes called a "cheater coat" and will decrease the occurrence of dry weave in the finish glass. Whether or not to seal the wood often debated. It will add a few hours to the glassing process but the pro glassers do it because it works.

It is common for bubbles to form as the resin cures. These bubbles are caused by the resin displacing air as it seeps into the porous wood (see picture on the right). Watch over the board closely until the resin gels so you can brush out bubbles as they form. Any bubbles you miss can be sanded out once the resin cures.

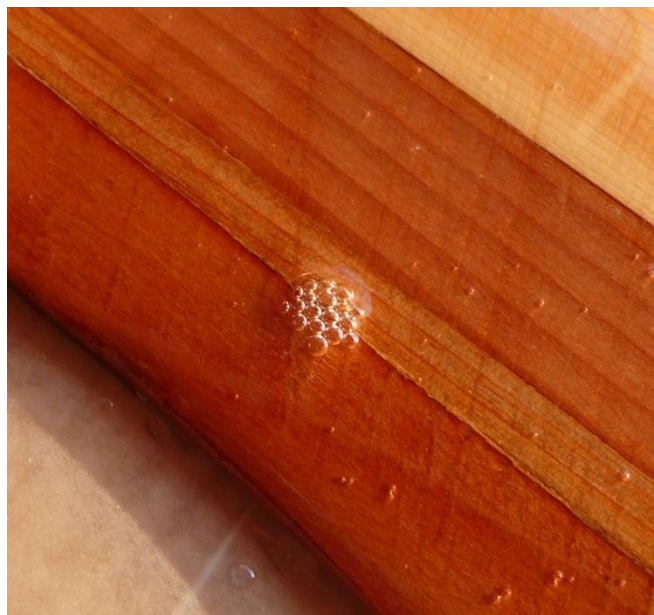

## CH. 11 – GLASSING & FINISHING

### Preparing to Glass the Board

Glassing a surfboard isn't rocket science but it is tricky. There is no shame in having the board professionally glassed. You have a lot of time and money invested in this project and a sloppy glass job can ruin your hard work. If you are determined to glass the board yourself, you should be familiar with glassing techniques before starting. This book is not meant to teach you glassing skills. There are plenty of on-line sources that provide this information. This chapter will give you an overview of what you need to do to finish the board.

### Epoxy or Polyester?

Welcome to the great debate! Somewhere the word got out that polyester will delaminate from wood. That's only partially true. Its sticks great to balsa, paulownia, redwood, bass wood, pine and many others. Epoxy also sticks as well. Here is a comparison of the two resins:

#### Epoxy Pluses

Weighs slightly less than polyester, cures very clear, low VOC (fumes), can be cleaned with common thinners – even vinegar!

#### Epoxy Minuses

A little more expensive than polyester, harder to use as a gloss coat, longer drying time. Extremely sensitive to proper mix ratio.

#### Polyester Pluses

Less expensive than epoxy, gels and cures more quickly, cure time can be varied by adding more or less catalyst.

#### Polyester Minuses

Much higher VOC with a very strong odor, may eventually delaminate from some exotic woods.

The debate will surely rage on . We have successfully used both systems on wood boards and will continue to do so. No doubt epoxy is better for the environment than polyester so it that's your motivation the decision is easy.

### Materials Needed

You will need mixing cups, stirring sticks, disposable paint brushes, tape, dust filter mask, squeegee, and disposable gloves. The red 16 oz plastic beverage cups are perfect size and are cheap. Use disposable bristle and foam paintbrushes since good brushes are too hard to clean and almost never work right afterwards. Blue painters tape is the best to use and a plastic squeegee can be cleaned over and over. The tack cloth is used to remove dust prior to glossing. You should also have a roll or two of good paper towels and a drop cloth for the floor.





## CH. 11 – GLASSING & FINISHING

### Summary of Glassing Steps

The following sequence summarizes the glassing steps. These steps assume that the board is finish sanded. They also assume that a dark wood strip was applied as the first layer of the rails to form a pin line. Read completely and go through the photo steps which follow before starting to glass the board.

1. Always glass the deck first. Turn the board so the bottom is up and run a line of masking tape around the board at the inside edge of the pin line. Let the inside edge hang free like a skirt. You can add a rolled-up wad of tape or a small scrap stick behind the lower edge if needed to make it hang free.

### IMPORTANT!

***Always mix the resin and hardener exactly according to directions!*** This is especially important with epoxy. If the chemicals aren't in the proper proportion the resin will never cure. Epoxy isn't like polyester where you can add a little extra catalyst to make it "go off" faster. *The mix has to be correct!* The best way to make sure you get the mix right is to mix by weight using an accurate scale such as a postal scale but, again, follow the directions! Some resins are thicker than the hardener so the weight ratio is different. Follow the directions!

2. Turn the board over and seal the deck with a coat of resin. This is called a cheater coat. Let it cure completely (this step is optional but highly recommended).
3. Drape the board in glass cloth and trim the cloth so it will wrap around the rails and go slightly onto the tape on the bottom.
4. Pour the resin down the center and squeegee it out evenly. Work it around the rails, tail, and nose so that the glass is smooth all the way around the rails and touches the tape skirt.
5. Before the resin completely cures rock hard, turn the board over and trim the cloth around the tape line with a sharp razor blade. Remove the tape and excess glass.
6. Flip the board over and allow the resin to cure (usually 12 - 24 hours for epoxy but check the label)
7. Flip the board over again so the bottom is facing up and lightly sand to feather the edge of the glass where it was trimmed.
8. Flip the board over again and run another masking tape skirt around the pin line on the deck glass.
9. Turn the board so the bottom is facing up and seal the bottom. Drape the glass cloth just like the deck was done. Cut the cloth around the rails so that it just goes onto the tape skirt on the deck.
10. Pour the resin and squeegee it out and around the rails just like the deck was done. When the glass is set (but not fully cured) turn the board over and use a fresh razor blade to cut the excess glass off at the tape line. The rails now have two layers of glass on them.
11. Turn the board bottom side up and allow the bottom glass to fully cure.
12. Lightly sand the line where the glass was cut and run a tape skirt around the pin line of the bottom the same way as was done before. Put the second layer of glass on the deck.
13. Cut off the excess glass as was done before. You will now have two layers of glass on the deck, one on the bottom and the rails will have three layers. Lightly sand the cut line to feather it into the bottom glass.
14. Hot coat the deck and when its fully cured turn it over and hot coat the bottom. Be sure to run a tape skirt around the middle of the rails to let the resin run off instead of sticking to the bottom surface.
15. Install the fin or fin box and leash cup as described in Chapter 11.



## CH. 11 – GLASSING & FINISHING

### Summary of Glassing Steps (cont.)

16. The board can now be completely sanded. Use 80 grit sandpaper to even up the glass lap lines at the rails and remove any high spots. Most sanding should be done with 100 to 150 grit paper and gradually work to 220 grit for final sanding. Block out the glass until there are no shiny spots. Shiny spots are low spots and will show when the board is finished.
17. Once the board is completely sanded and there are no lumps, gouges, low spots, high spots etc. it will have a milky white appearance. This is because of the millions of fine scratches in the hot coat made by the sandpaper. The gloss coat will fill these scratches and make the glass perfectly clear. Many builders use polyurethane varnish or an automotive clear coat for the gloss coat. This will give the UV protection that most epoxy resin's don't give. UV rays will destroy the glass cloth over the course of a few years of sun exposure.
18. Carefully clean and wipe down the fiberglass surface. Use a Tack Cloth just before finishing. Spray or brush the gloss coat on the surface according to the manufacturer's recommendations.
19. If you are brushing on epoxy for the gloss coat use a foam brush and apply the thinnest layer you possibly can. If you build it too thick it is very likely to "fisheye" or make little "craters" that will be a pain to sand out.
20. Once the gloss coat is dry, wet sand and polish as desired.

### Resin Additives

There are additives that can be used in the final gloss coats or hot coats that will help give a better finish than you would get using plain resin. These additives help the finish coat flow and cure better. If you are using an additive, make sure it's the right one since an additive made for one brand epoxy generally will not work in any other brand. Also, follow the directions carefully.

Polyester finishing resin is simply laminating resin with a surfacing agent added. Without surfacing agent the surface of the resin will be "tacky". Add surfacing agent to laminating resin according to directions.

### Successful Glossing With Epoxy Resin

Many builders complain that you can't get a good glossy finish coat with epoxy. Things like fisheyes and orange peel are common problems. Well, it can be done and it's easier than you think. Here are the steps:

1. Finish sand the fiberglass using at least 400 grit paper to remove all scratches.
2. Wipe the glass surface with a rag or paper towel moistened in a grease-removing liquid. You can get it at paint supply stores or on line at places like Eastwood.com. Let it thoroughly dry.
3. Wipe the surface down with a good quality tack rag. Cheap ones can cause fish eyes. It goes without saying that there should not be a lot of dust in the air or on the floor where you are glossing.
4. Use a wide paintbrush to apply the epoxy. Mix a little more than needed because you want it to flow out. Use an additive such as "Additive F" to enhance flow out. Apply a generous coat of resin.
5. Generously paint the epoxy on the surface. Run long, slow strokes from nose to tail. Press hard to make the coat thin,
6. Walk the board doing single strokes from nose to tail to make sure the coat is even (it will run off the rails so protect the floor and make sure you have a tape skirt as previously described).
7. That's it. Let it cure, finish sand it, give it a light polish and it's done.

## CH. 11 – GLASSING & FINISHING

### How Much Glass?

Most glassers apply two layers of cloth to the deck and one to the bottom. Some use 4 oz. cloth and others use 6 oz. Some even use a combination of the two. Many glassers will apply both deck layers at the same time but this is not recommended for the inexperienced since it offers a greater chance of getting cloth that is not completely saturated by the resin. Dry weave is ugly and weak.



Run a strip of masking tape around the rail just below the apex. Let the edge hang free like a skirt so the excess resin will drip off instead of running around and sticking to the bottom.



Roll out the glass cloth and cut to length. Next, trim the excess cloth. Save the scrap cloth for mounting the fin or for repairs later.



Cuts are made to allow the glass to form around the curve of the rail. These cuts aren't really necessary with 4 oz cloth but help with the 6 oz.



Mix the resin and pour it down the center of the board. Start with the squeegee from nose to tail until its covered. Then work out to the rails.

## CH. 11 – GLASSING & FINISHING

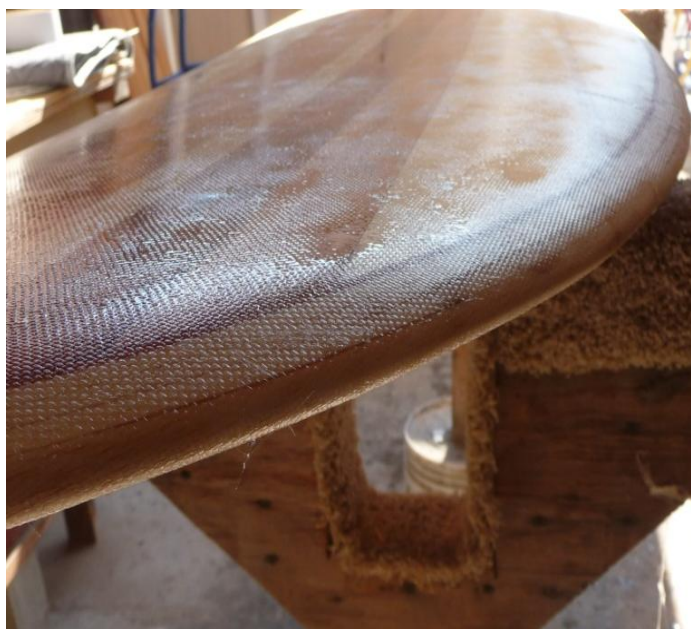

Work the resin out to the edge and wrap the rails around to the bottom till it touches the tape skirt. The glass should be smooth but you will see weave. When tacky, the hot coat is brushed on.



Once the hot coat is dry, make another tape skirt and flip the board over to do the other side. You can roll up a little wad of paper as shown and put it behind the tape to hold the inside edge up.



The tape skirt makes an edge for the glass that is lapped around the rail. Once the resin is tacky, use a razor knife to cut along the tape line. If you are careful only minor sanding will be needed and the seam will be invisible after the board is finished.



Make another tape skirt before the sanding coat of resin is applied. You never sand the board with weave showing! Always apply a sanding coat of resin. It's the resin that gets sanded, not the cloth. Sanding cloth will make you itch. Do the deck and then the same thing to the bottom.

## CH. 11 – GLASSING & FINISHING



Sand the hot coat. Make sure all little drips, ruts, and puddles are even. Use a long board sanding block and finish to at least 220 grit paper. The surface will be cloudy because of the sanding but will become perfectly clear when the gloss coat is applied. Make sure there are no shiny (low) spots.



The fin box is installed and the fiberglass line where it ties into the bottom is feathered and blended. Double check that the fin box is completely sealed.



This is why you should use a tape skirt around the rails every time you apply resin. Some will always run off and this saves you a lot of sanding. Remove the tape when the resin gets tacky.

## CH. 12 – FIN BOX

### Fin Box

There are many types of fin boxes available. This procedure will cover the installation of a *Fins Unlimited* fin box. Other brands will have different procedures. Originally it was planned to use a glassed-on fin on this board. We changed our mind and decided we wanted a fin box instead. Since the bottom was already planked without the balsa blocks being installed as shown in Chapter 6 it was necessary to add a block in the tail. The following sequence was used.



A solid balsa block is cut to size. Tape is placed around the block to show where to cut the board.



A Dremel tool and cut-off wheel are used to cut through the fiberglass and into the wood.

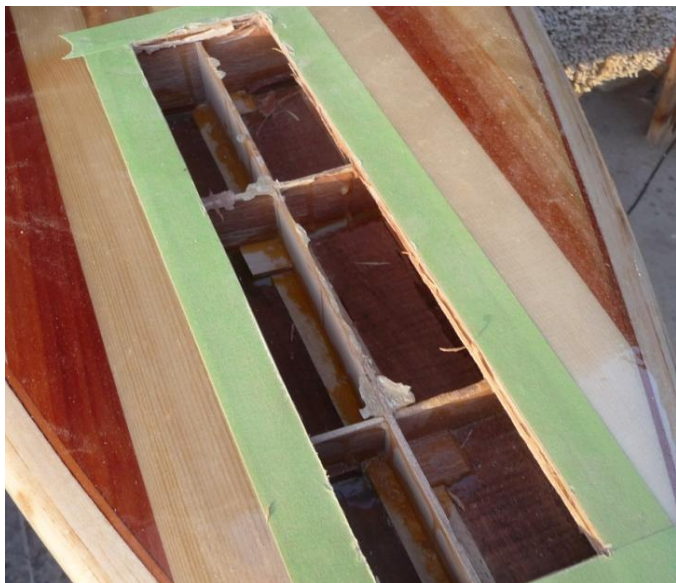

When the planking is removed the ribs and spar are exposed



The ribs and spar are cut and removed and the area is cleaned of debris.

## CH. 12 – FIN BOX



Epoxy resin is thickened with milled glass fibers and poured into the cavity. If fibers are not available use talc powder or micro balloons available from a hobby shop.



The balsa block is not pressed into the cavity so that it is seated firmly in the epoxy glue.



After the resin sets the balsa block is sanded even with the surface of the board. Use the fin box to make a router template that is about 1/16" larger than the box.



The template is placed over the board and a router used to make a proper hole for the fin box. Use plenty of tape to hold the template solid while the hole is being routed.

## CH. 12 – FIN BOX



Using the router and template, a perfect hole is made for the fin box. If the balsa blocks had been installed before the bottom was you wouldn't see the balsa box in the finished board.



The fin box sits on 6 little tabs and the lip sticks up about  $\frac{1}{4}$ " above the surface. This is to prevent resin from getting inside when its being installed. It will be sanded down even with the board surface after it's glassed in place.



Paint some epoxy all over the inside of the cavity and cut two pieces of fiberglass cloth as shown. Saturate the cloth push it into the cavity. It will bunch at the ends but that's OK.



Put the fin in the fin box – don't skip this step or chances are you won't get the fin box in straight. Push the fin box into the cavity and saturate the cloth around the fin box. Squeegee the lumps and bubbles out.

***Before the resin dries stand back and make sure the fin is straight and perpendicular.***

Once the resin is set, sand the fin box even with the surface, feather in the glass that was added and finish the area to match the rest of the board.

## CH. 13 – LEASH CUP

### Leash Cup

Commercial leash cups are available from several sources (see links page). The easiest way to mount them is to drill a hole in the deck using a hole saw or Forstner bit. Pigment is mixed with epoxy and used to glue the cup in place. When the cup is properly installed and the excess resin is sanded even with the deck it will appear to be one solid piece with no glue line.



Drill the hole for the leash cup using a hole saw or Forstner bit. The drill bit in the center has been cut down so it won't go through the board.



Mix some epoxy and add the correct pigment. This can be purchased from the suppliers on the links page.

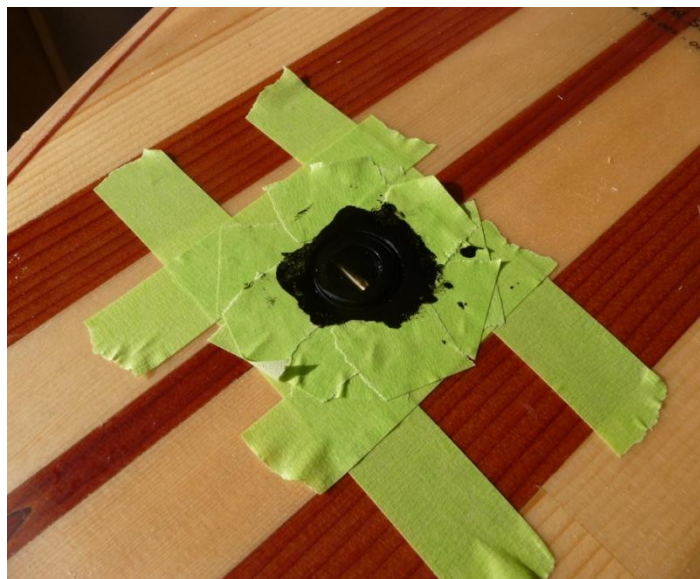

Tape the deck for protection and put a small amount of the pigmented epoxy in the hole. Don't overfill or it will make a huge mess. Trial fit the plug and make sure the epoxy doesn't run over the edge and into the cup.

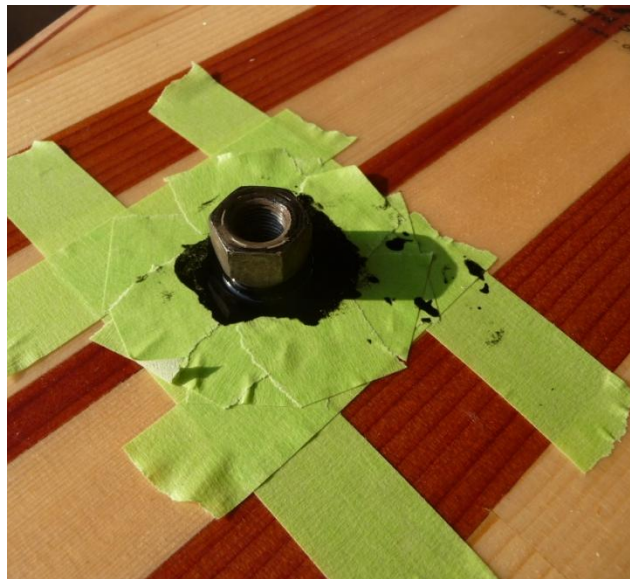

Use a weight such as an old lug nut to hold the cup from floating while the epoxy cures. The epoxy should form a ridge around the top of the cup. It will be sanded even with the deck after it cures.

## CH. 13 - VENT

### VENT INSTALLATION INSTRUCTIONS

Thumbscrew

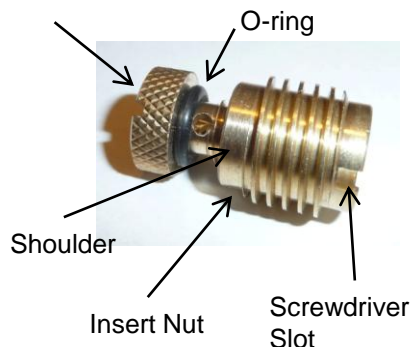

Install the block *before* the bottom of the board is attached!

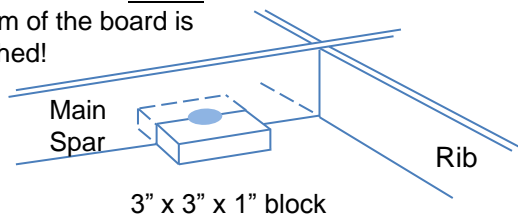

Notch main spar and glue wood block to the back of the deck with half of the block on each side of spar as shown. Drill the hole through the deck and through the block with the hole extending into the spar. This will make an opening on each side of the spar so both sides of the board can vent.

Drill a 9/16" hole in the deck. Remove the thumbscrew from the vent assembly and use the screwdriver slot on the insert nut to thread it into the wood deck block. *It should turn easily and make shallow threads in the wood.* Unscrew the insert nut, remove the O-ring from the thumbscrew and screw the thumbscrew into the insert nut on the flat end. Apply epoxy to the insert nut threads and screw it back into the deck with the screwdriver slot on the bottom. Screw it down so the top of the insert nut is flush with the deck. The shoulder around the insert nut should be filled with epoxy but keep it out of the threads. Re install the O-ring on the thumbscrew. The thumbscrews do not have to be fully removed to vent the board.

#### Alternate Mounting Method

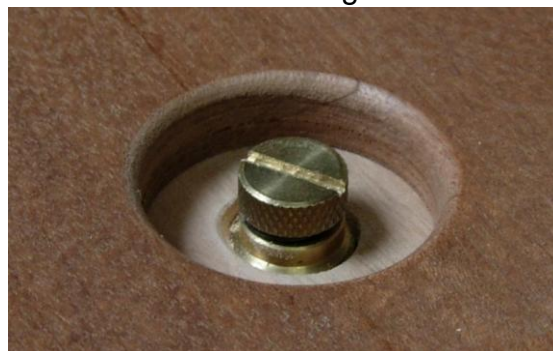

Create a recess in the deck of the board so the top of the vent screw is even with the top of the deck.

#### Installing a WSS plastic vent screw



Remove the original vent and drill a 5/8" hole for the retrofit plastic vent plug. Trial fit the vent in the hole. It should be snug. Apply generous coating of epoxy to the sides and press the plug into the hole. Wipe off excess epoxy and hold the plug down with a weight until the epoxy cures.

#### Make your own vent

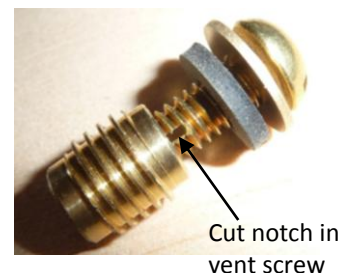

Cut notch in vent screw

Here are the parts required to make a vent.

- 1/4-20 x 1/2" brass screw
- #14S brass flat washer
- 1/4" inside diameter neoprene flat washer
- 1/4-20 internal thread insert nut

## APPENDIX A

### WHAT WOOD TO USE

#### ALL ABOUT WOOD

***One of the most common questions builders have is how much does the wood cost and where do I get it?***

You can purchase premium timber or you can go through piles of lumber at the home improvement store hoping to find one or two really nice pieces.

***Surfboards that are 6 feet long or shorter can be made from redwood and cedar fence boards that only cost a couple dollars each.*** If you take the time to search through a pallet of fence boards you will almost certainly find a few nice, clear pieces. You can also find nice wood in the garden department of home supply stores like Home Depot or Lowe's. There is almost always a couple nice long redwood boards in the pile of wood sold to be used as a planter border.

#### What Wood is Best?

If you are like me the first answer is "Free wood is best". Maybe not though. Exotic hardwoods are great for wall hangers and boards where you don't care about weight. We did a comparison of wood weights and here is what we found.



We cut a piece of wood  $7/8$ " wide,  $5/16$ " thick, and 11" long of our four most commonly used woods and labeled them.



The woods all had basically the same moisture content. We weighed each piece on a digital scale. I use this scale to mix small batches of epoxy so I know its pretty accurate.

Balsa was the lightest followed by paulownia, redwood, and pine. No surprises really. Our opinion is that the best wood for a hollow wooden surfboard is balsa and paulownia. The paulownia is very close in weight to balsa but much stronger. It is also a fast-growing and very sustainable wood.

#### FREE LUMBER!

***Its true! Free lumber is available if you are in the right place at the right time.*** Cabinet shops throw away more nice lumber than you can imagine. Its not because they are wasteful, its just that a busy cabinet maker generates a lot of scrap and most don't have room to store it all. If you check the dumpster or scrap pile several times a week (*with their permission of course*) you probably will end up with some nice free lumber. Even better, if you get to know the owners you may be able to convince them to save it for you. Also many of these shops may be willing to plane or custom cut wood for you too. Its all about your "people skills".

## APPENDIX B WOOD REPAIRS

### Invisible Repairs

The pictures below show how to repair a low spot in the balsa rails. Simply glue a piece of balsa with similar grain and color in the dent and sand it smooth after the glue dries.



This is the area to be repaired. Wood putty will show so we'll use real wood.



Glue a piece of balsa with similar color and grain into the damaged area.



Allow to dry and cut away the excess wood.



Block sand the area with 120 grit paper.



The finished repair blends perfectly. Wood putty would have been visible and ugly when glassed.

## APPENDIX B WOOD REPAIRS

### Don't Use Wood Putty – Ever!

No matter how close the color of the putty looks to the wood it will stand out like a neon sign when the board is glassed. Taking care to make perfect joints is the best way to avoid cracks that you will be tempted to fill with that nasty wood putty. Some people advocate the use of wood flour and glue. These are still visible and actually scream out “amateur”. Here is a better way to fill cracks that is virtually impossible to see once the board is glassed.



One of the most common gaps will appear where the rails are glued to the board. No matter how hard you try these things happen.



Cut a wood strip from wood that is similar color and grain as the wood near the gap. Use a hobby knife or razor blade and sand to size.



Stuff the wood strip into the gap and lightly sand it even with the board surface. By carefully selecting wood that is proper color and grain the finished repair is virtually invisible. This process is more demanding than simply filling the gap with putty but you will be much happier with the results.

## APPENDIX C ONE-PIECE BOTTOM

Since the bottom only needs to bend in one direction (with the rocker) it is possible to install a one-piece bottom instead of planks like were used on the deck. Either a single piece of plywood or a piece laid up from individual strips can be used. The strips do not necessarily have to match the deck pattern.



Lay the strips out in the pattern desired. Tape the strips together starting in the middle so that there are no gaps.



Run an additional strip of tape along every joint. This will act like a hinge for gluing the strips into a solid piece.



Turn the piece over and move it to the edge of the table. Allow it to hang over so the joint is open. Run a bead of glue into the gap and move on to the next strip. Repeat for all joints.



Position weights as shown so the piece doesn't curl while the glue is drying. The tape will keep the wood from sticking to the table. Put a piece of plastic film under each block to avoid sticking.

## APPENDIX C (CONT.) ONE-PIECE BOTTOM



When the glue is dry and tape is removed, lay the solid bottom piece on the table and place a wood block under the nose and tail so that the wood curves to the approximate contour of the surfboard rocker.



Apply a generous bead of glue to the bottom of the frame making sure to coat all the ribs, rail strips and spar. Turn the frame over and place it onto the bottom piece. **Check that it is centered!** Place weights as shown so good contact is made.



Use wedges cut from scrap wood to make the edges of the bottom piece contact the rail strips. The weights ensure the center is making good even contact.



Use as many wedges and weights as required to get perfect contact all around the rails. You know it's a good joint when excess glue squeezes from the rail strip.

## APPENDIX D MODIFYING THE SHAPE

The standard board outlines (length and width) can be modified if desired however the thickness cannot. The following sequence shows how the standard 7' 6" egg was modified into a 7' 4" semi gun.



This is the how the 7' 6" egg looks before the rails are installed.



This is the same board after being changed to more of a semi gun shape



This is the new semi gun shape with the rails installed.



Some of the wood removed in the reshaping of the egg into a semi gun.

### BEFORE YOU START CUTTING

*A word of caution: the standard 7' 6" egg is a proven design and is a superior performing surfboard. If you change the shape as shown here, you will change the characteristics of the board and will alter its performance. Just because a board looks cool doesn't mean it will work well. Good riding boards don't just happen, they get refined and evolve through trial and error.*

## APPENDIX D (CONT.) MODIFYING THE SHAPE



Mark the proposed new outline using thin masking tape. Lightly pencil guide lines on the wood. The board is trimmed to shape using a band saw or saber saw.



Once the first side is cut, lay paper as shown and tape the edge exactly in the center of the board. Trim the outside edge using a razor blade. You now have a perfect template of the left side of the board.



Flip the paper over and mark the right side. This will ensure that the two sides are exactly symmetrical. The nose is done in the same manner.



After the new shape is cut, the rail strips are completely gone - but the structure remains straight and strong. Making the board narrower made the rails a little thicker.

## APPENDIX E BUILDING THE FISH

### FRAME

The fish surfboard is built almost exactly the same way as the other boards with a few exceptions. This Appendix discusses those differences and how to deal with them.

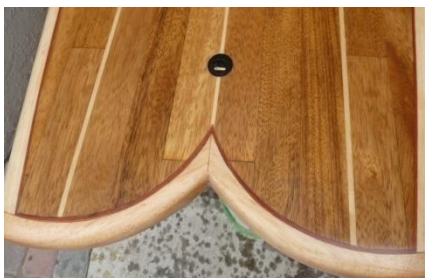

This is the fish shown being built in this section. The deck is made from recycled mahogany door frames with cedar stringers, balsa rails and tail block. First layer of the rails is a 1/8" redwood strip for the pin line. Bottom is 1/8" oak ply with glassed-on twin fins.

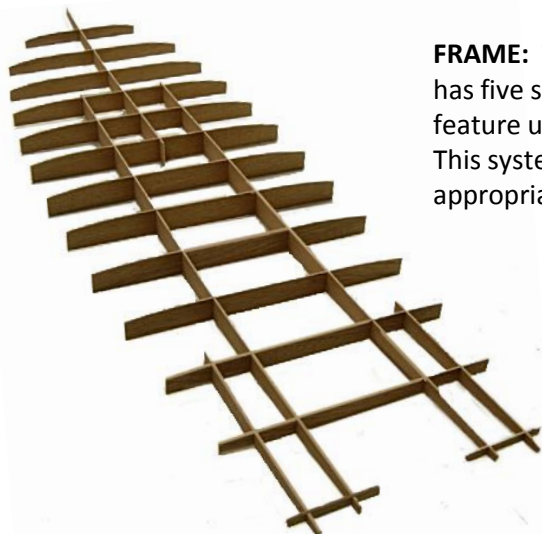

**FRAME:** The frame is quite different from the longer surfboards. It has five shorter spars instead of a single center spar. This is a design feature used exclusively by the Wood Surfboard Supply Inc. kits. This system ensures that a short wide structure such as the fish is appropriately rigid.

**TAIL:** The tail area of the fish endures significant stress and is designed to accommodate multiple fin setups. For this reason two additional spars are located in this area.

**CUTOUT:** A cutout area in the rear allows the swallow tail that is the signature setup for a fish to be implemented without having to interfere with the center spar.

## APPENDIX E (CONT.) BUILDING THE FISH



All the frame pieces are slipped together without glue. The swallow tail template is not included in the export kits because of its size. Cut a paper template to find the swoop you want for the tail.

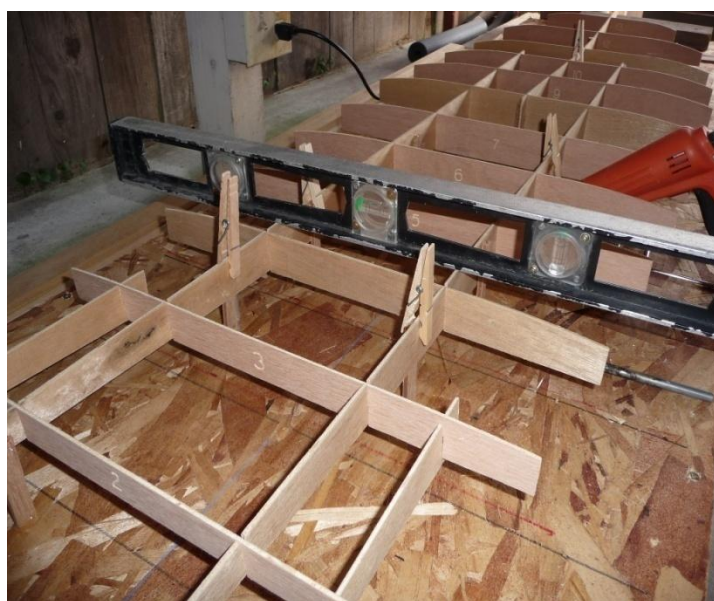

The two long spars are leveled and mounted a couple inches above the building table. Hot melt glue is used to secure the frame to the table.



1/8" square wood strips are attached to the top and bottom edges of each rib with CA glue. They are allowed to run "wild" at the nose since bending them to the finish contour is impossible without snapping them.



The rail strips at the tail will be trimmed even with the ends of the spars. All the rail strips that were glued to the end of the ribs using CA glue now have a bead of 5 minute epoxy applied for strength.

## APPENDIX E (CONT.) BUILDING THE FISH



The center strip is glued in place. Card must be taken since the center spar does not run the full length of the board. Measure and mark the centers of the rear ribs to align the center.



$\frac{1}{4}$ " square wood blocks are glued to the upper edge of each rib and the spar to provide additional gluing surface. The blocks are glued to either the front or back of each rib.



The deck is planked the usual way, using stretched-out plastic film. After the deck is complete it's released from the table and flipped over so gluing blocks can be applied to the ribs the same way they were on the deck.



The bottom will be covered with a  $\frac{1}{8}$ " thick piece of red oak plywood. Carefully measure and mark the center so the book matched grain pattern will look right.

## APPENDIX E (CONT.) BUILDING THE FISH



The deck is rough trimmed and the frame is set in place over the oak plywood. An outline is drawn about ½" out from the rail strips. The bottom is then rough trimmed to the outline.



Generously apply glue to the bottom of the frame and set it on the bottom piece. Check that the center is exactly where you marked it. Weight the board and clamp as shown. Wedges can be cut to ensure the bottom is tight against the rail strips.



Now that the deck and bottom are glued in place the outside shape is finish sanded. Sand up to the rail strips. Use the template supplied with the kit for the tail shape.

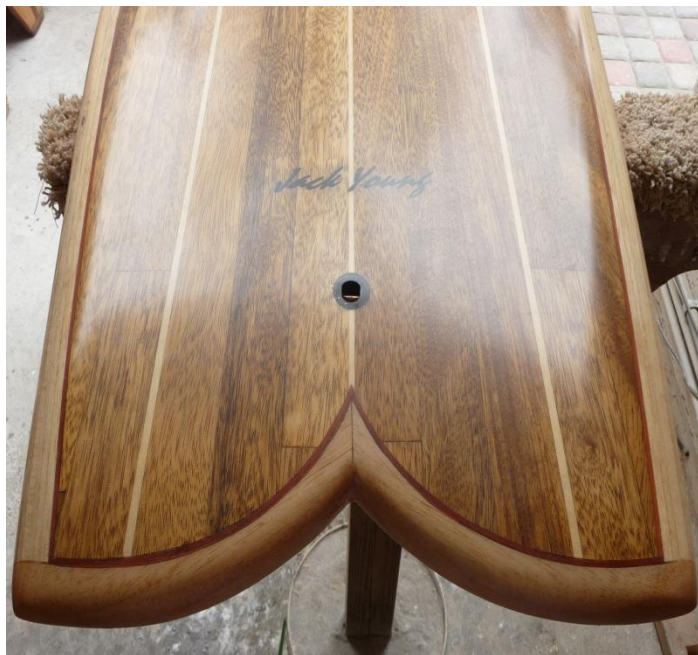

The tail block has to be cut from a block of wood, in this case balsa. To get the pin line the wood has to be bent beyond the breaking point. To bend it we needed boiling water.

## APPENDIX E (CONT.) BUILDING THE FISH

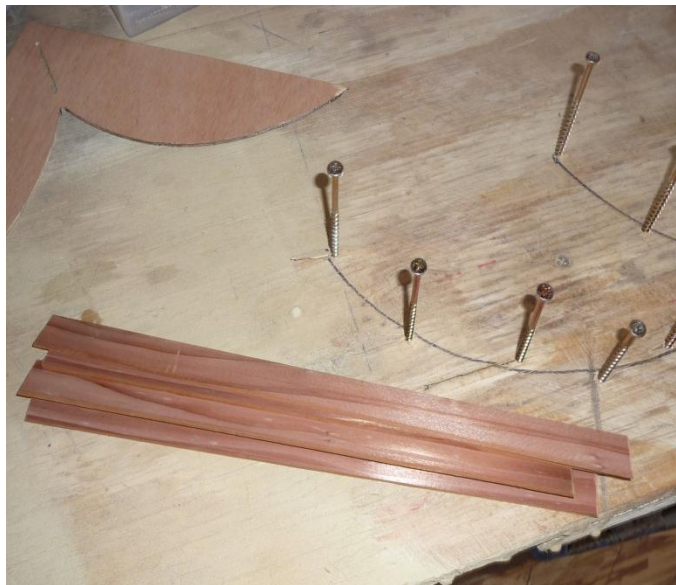

Follow the template used to cut the tail and draw the proper arc on the tabletop. Use long deck screws placed on either side of the line to make a bending form.



Boiling water is poured over the wood strips and they are allowed to soak for about 5 minutes. The hot water makes them quite easy to bend. If they start to crack when you bend them put them back in some more hot water for a few more minutes.



Slip the wood strips into the bending form and make sure they follow the curve marked on the table. You will need to remove a couple screws to get the wood strips in place.

Allow the strips to dry completely. They will retain most of their new shape when they are removed from the bending form.

The dry wood strips are glued in place in the swallow tail and held with tape until the glue is dry. Instead of tape, a brad from an air nailer can be used if there is sufficient wood to nail into.

To complete the tail, use a block of balsa or other light wood and cut it to shape. Take your time here. Getting the curve perfect means you will have a nice, tight seam and it's a tedious process - but worth the effort. Keep checking and sanding a little at a time until the block fits the curve perfectly. You'll end up with a glue joint you can be proud of.

## APPENDIX F – ASSEMBLING THE EXPORT KIT SPAR

### Export Kit Spar Assembly

The spar in export kits has been cut to size for international shipping and must be re-assembled using backing plates to reinforce each glue joint. A spar that has been properly assembled exhibits no loss of strength as compared to an un cut spar. Assemble the spar(s) as follows:

1. To prevent damage during shipping the frame pieces are bundled with the ribs. This will protect the thin nose and tail areas. Separate the ribs from the spar pieces and lay out the spar as shown below. Note that in some kits the spar may have as many as 4 parts.



2. Locate the wood supplied to make the backing strips. They are bundled along with the spar pieces. If no wood strips are included in your kit, use any strong, light wood to make the required number as shown in the circle below.

**Note:**

You only need a wood strip on one side of the spar. Putting wood on both sides will add weight and isn't really necessary.



3. Carefully align each joint, apply glue to the back of the gussets and put one on the each side of the spar

4. Put a weight in each glue joint and allow the glue to completely dry. You can use a piece of plastic under the block to make sure excess glue doesn't stick the spar to your bench.

## APPENDIX F – ASSEMBLING THE EXPORT KIT SPAR

### Robert August Export Kit Assembly

The spar for the Robert August “What I Ride” kit has been cut just like those in the other export kits but it has a couple extra parts. The “halo” for around the nose concave has to be cut into 4 pieces and the template for locating the fins is also cut. See the pictures below for details on how to assemble them.



Early versions of the nose concave halo contained 4 pieces as shown. WSS now only cuts the halo into two pieces making assembly easier.

Cut a small piece of wood from the scrap supplied with the kit and glue the pieces together at the four joints.



The fin location template is cut and folded for shipping. The tape hinges keep the pieces in order.

Just lay the pieces out flat and glue the cuts to you have a single template again. This template will show the exact location of the fin box and optional side fins.



# APPENDIX G FIN LOCATION

## Selecting a Fin

**Glass on fin:** The most basic way of attaching a fin to a surfboard is to glass it on. Glass-on fins are strong and maintenance free but don't allow you to move or change the fin to match changing surf conditions.

**Removable fin:** A removable fin system allows you to try different fins and fin locations as well as making transporting the board easier. Some of the systems available allow the fin to be moved back and forth several inches as well as allowing you to change the angles it is mounted.

Removable fin systems consist of a fin box that is permanently attached to the board and some way of securing the fin in it. Each system has merits and drawbacks. If you have other boards with a certain system our advice is to stick with it. This will let you change fins and experiment.

**Which one is best:** Each builder will have to decide which is best for them based on factors such as price, availability, and compatibility with your other boards. That last one is a big deal.

## Fin Terminology

**Toe in** – The outer fins (thrusters) are slightly angled toward the nose. Toe in is usually  $\frac{1}{4}$ " and not more than  $\frac{1}{2}$ ". Toe in helps turning but too much of it will increase drag and slow the board down. On boards over 9' the toe in will usually point at the center of the nose.

**Cant (rake or splay)** – In multi fin systems the outer fins are sometimes angled toward the rail somewhere between  $0^\circ$  and  $8^\circ$ . This is called the cant, rake or splay. Cant gives lift at the nose but it increases drag and slows the board down.

**Fin Location:** These measurements are a good "general placement" specs that will work well for you if you simply have no idea where to place your fins. We arrived at these measurements by averaging the placement of many boards that we know surf very well.

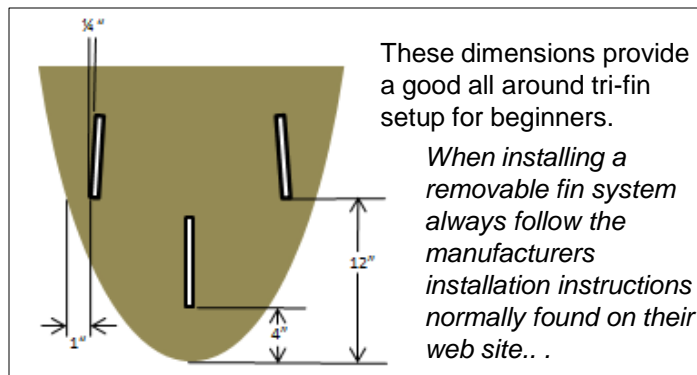
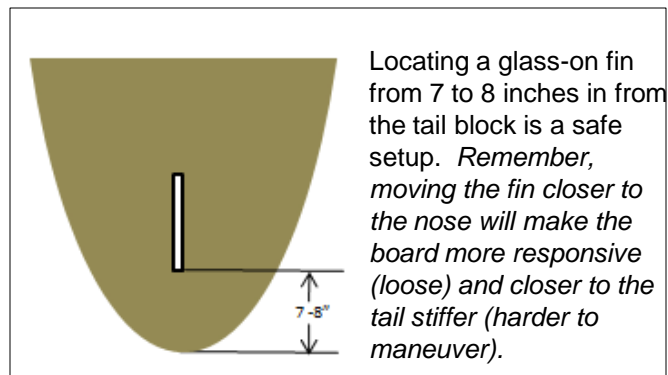
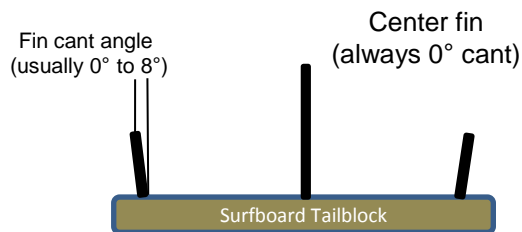
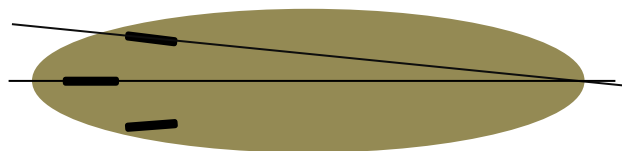

**The best method of determining fin placement is to measure and copy a board that you like.** If it works there it will work here. If you don't have a board to copy, try checking a nearby surf shop. We have found our local shops are very interested in these boards and usually happy to help.

## APPENDIX H

# CONVERTING AN SUP TO A WINDSURFER

### Parts Needed

In addition to the leash cup and vent that would normally be installed on the SUP, the following parts are needed to turn it into a good windsurfer.

- **Fin and Heavy Duty Fin Box:** The fin on a windsurfer is subject to lateral forces that far exceed what a surfboard experiences. A quality, heavy duty box is necessary. Regular fins will still fit the box.
- **Mast Box:** A mast box mounted at the center of the board will allow the sail to be securely held in place. It also allows fore and aft adjustment to get perfect trim of the board.
- **Balsa Blocks and/or Foam:** Balsa and foam blocks mounted as described below provide a proper mount for the fin box and mast box. Lightweight foam blocks help distribute the forces exerted by the sail evenly across the board. Balsa and foam are strong and very light.
- **Sail, Rigging, and Mast:** Sails in the range of 5.5 to 7 sq. meters are suggested. Larger sails can be used when the mast box is reinforced with the foam blocks as shown. Sails are readily available at many surf shops and on line.



Orca combination Stand Up Paddleboard and Windsurfer. This board was built by Andrew Borg in Malta. It uses a 7 sq. meter sail for power. Here is what Andrew said about the conversion:

*"The Orca I converted into a sailboard really handles well. It gibes great and tacks with ease. It also goes upwind well and is a well mannered, very pleasant, super-stable board. It's great for beginners and doubles up as an excellent board to use in flat water, free style hot dogging or riding waves. It really is a great big free ride board and it would be a sin for anyone to build the Orca and not add on a deck box and sail.".....Andrew Borg*

# APPENDIX H CONVERTING A SUP TO A WINDSURFER

## Installation of the Mast Box

The mast box is installed just like a fin box in a conventional surfboard – except its in the deck. Prober blocks must be installed in the location shown to provide ample mounting surface.

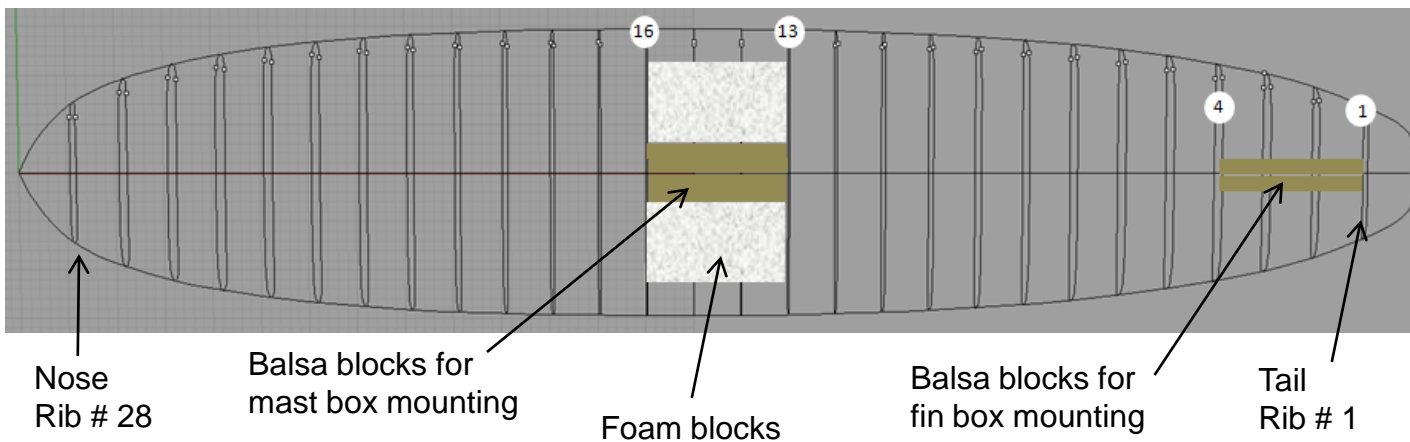

As a minimum 1½” wide balsa (or other light wood) blocks are needed for the mast box mount.



Foam blocks are recommended when sails larger than 7 sq. meters will be used.



Wood blocks need to be added for the fin box and leash cup. Glue blocks from rib 1 to the back of rib 4.



The mast box and fin box are installed after the board is glassed as described in chapter 12 of this book.



Quality components must be used. The kit shown above is available on line from [www.woodsboardsupply.com](http://www.woodsboardsupply.com) and contains all heavy duty windsurfer-rated parts.

## APPENDIX I

# ROBERT AUGUST “WHAT I RIDE”

### Instructions Unique to the WIR

The Robert August “What I Ride” kit is built essentially the same way as the other Wood Surfboard Supply kits however it has a unique concave portion in the nose area. The building procedure for this concave area is contained in this Appendix. This kit also offers the builder the choice of making solid rails or hollow strip rails.

### Rails

As previously described in the “Rails” chapter, the WIR uses 60/40 rails and can be built as hollow strip rails or solid laid up rails. If you aren’t sure which one is best for you review the information in chapter 9.

### Nose Concave

At first glance building the nose concave for the WIR appears to be intimidating. Its really quite straightforward though. There are a few things to consider:

- Read and understand this entire section before you start gluing boards
- Use CA instant glue and accelerator to build the little “wall” around the halo. If you can’t find commercial accelerator you can dust some common baking soda on the glue to make it cure instantly. Using soda does leave a residue that may need to be sanded flush.
- Use a soft wood that is easy to sand in the concave area. Balsa or paulownia are best.



The “halo” that defines the nose concave is glued into the notches of the ribs as shown. Once the halo is installed a thin wood strip is glued to the center of the halo as shown. This forms a wall the same thickness as the bottom planking. Use CA instant glue. Weights will be used to force the planks flush against the ribs while the glue dries.



The wall is shown glued in place and the first plank installed in the concave. Note that the strip forming the wall only needs to be glued in spots so it forms a nice curve. On this board we wanted the finished thickness of the bottom planking to be 1/4” so that is the height of the wall.

### Note

*In export kits the halo is shipped in two pieces and must be glued together before being installed in the frame.*

## APPENDIX I (CONT.) ROBERT AUGUST "WHAT I RIDE"



Fitting the boards inside the concave wall gets progressively more difficult as you reach the outer boards. Take your time and make perfect joints because this part of the board will get a lot of attention.



The bottom planking was cut  $\frac{5}{16}$ " thick even though the final thickness is to be  $\frac{1}{4}$ ". When sanding the bottom of the board you will know the planks are the right thickness when they are sanded flush with the top of the wall.



The inside planking of the concave area is complete and the outside has been started. Fitting the outside planks is somewhat more difficult than the inside planks and requires patience. This photo shows why the wall was glued to the center of the halo strip. It provides a gluing surface for the planking on both sides of the wall.



A straight edge laid across the completed bottom shows the concave. The thin piece of redwood that was used to create the wall around the concave is now a nice pin line. The entire bottom of the board was sanded with a longboard sanding block to make sure the bottom was perfectly flat.

### Hint

Patience is the key word when fitting the boards to the inside and outside of the curve. Go slowly and take off small amounts of wood at a time. Avoid using power tools. Check and recheck every joint before gluing.

## APPENDIX I (CONT.)

### ROBERT AUGUST "WHAT I RIDE"



This board is getting solid, laid-up rails instead of the optional strip rails so the rib ends have been cut off at the score line as described in the Rails chapter. A nose block fabricated from balsa is clamped as shown while the glue dries.



Once the nose block is firmly glued you can start laying up the rail strips. To get tight joints start at the nose block and glue the first couple inches and clamp as shown. After its dry you can glue the rest of the rail strip and be certain of tight clean glue joints.

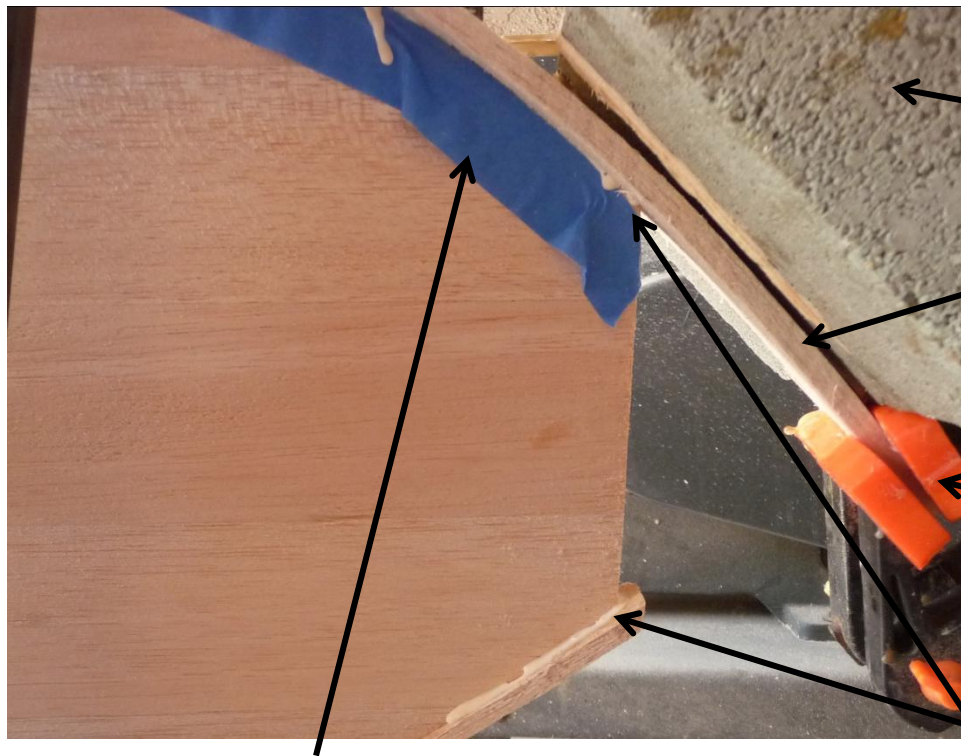

← Cement block weight

← Rail strip extends past the end of the board so it can be bent with the weight.

← Clamp to hold cement block weight

← Nice tight glue joints. Mom will be so proud!

Blue masking tape is applied to catch glue drips. It is much easier to catch them with a piece of tape then it is to sand them off later.

## APPENDIX J CLEARWATER SUP

### Instructions Unique to the Clearwater SUP

In spite of its unique appearance the Clearwater SUP is built the same way as the other wood strip boards. The following pictures show an overview of the process.

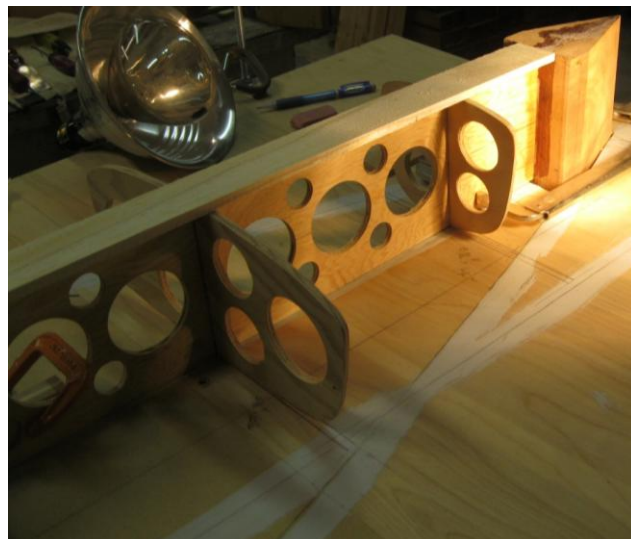
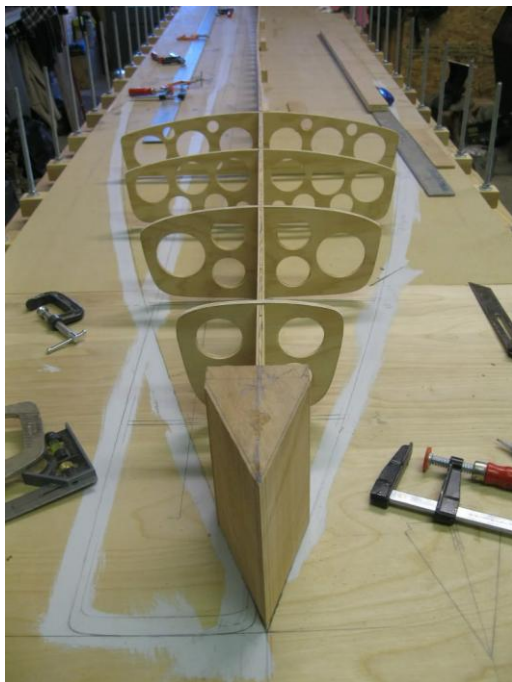

The Clearwater frame is built by sliding the slotted ribs into the matching slot in the spar. Take care to ensure everything is square and true before gluing.



This Clearwater frame is an early prototype frame made with  $\frac{1}{4}$ " ply. Current production frames use  $\frac{1}{8}$ " ply so the lightening holes shown aren't necessary.



The solid nose block used on this particular board requires that a notch be chiseled into the edge so the side strips can be faired in flush.

## APPENDIX J CLEARWATER SUP

In spite of its unique appearance the Clearwater SUP is built the same way as the other wood strip boards.

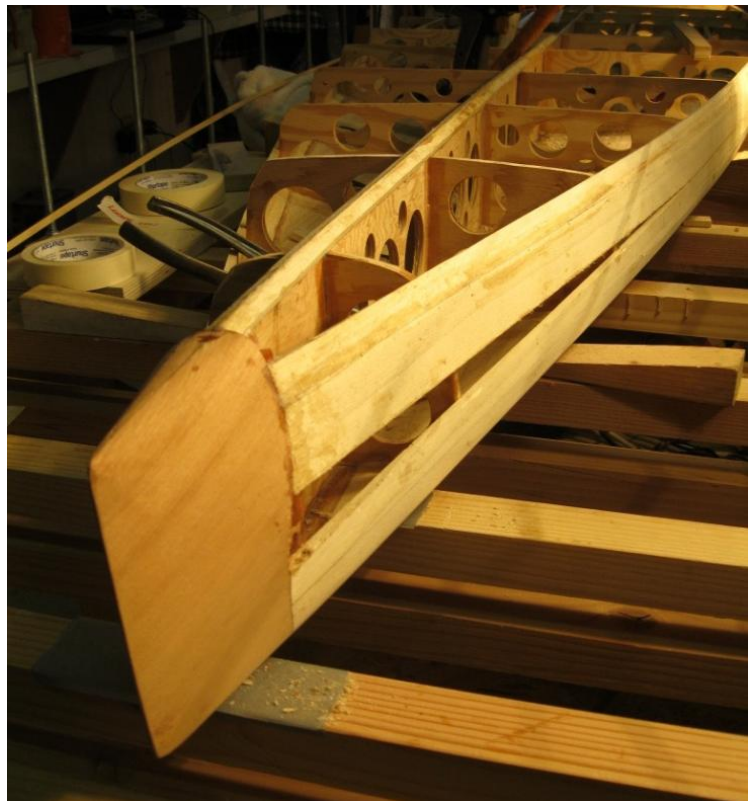

Use whatever combination of clamps and blocks to keep the frame square and true while the side planking is installed.

Installation of the side strips is straightforward. The gap shown above will require patience forming and fitting the final piece in place.

## APPENDIX J CLEARWATER SUP

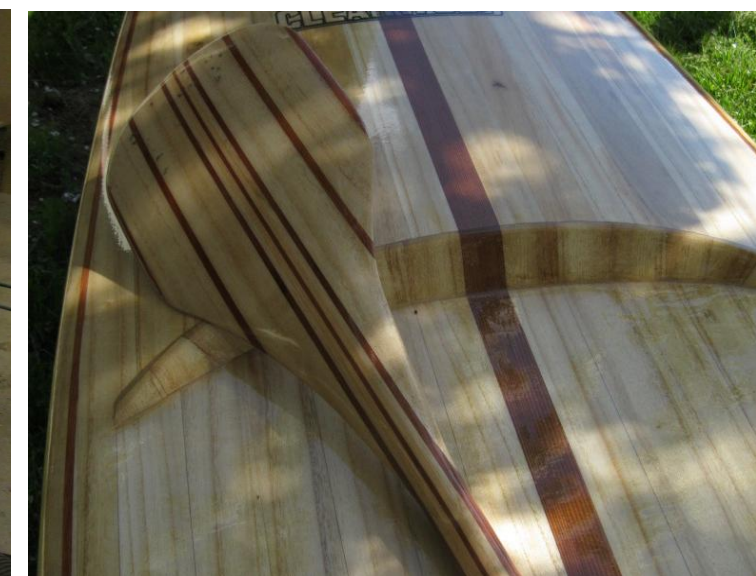

This Clearwater is being built without the solid nose and tail blocks. While adding a nose block gives a very nice appearance it results in a board that is somewhat heavier.

Also, the wood strip nose and tail blocks are easier to build because you don't have to fair the side strips into the block.

This picture shows the deck step along with a paddle that was built using the same paulownia and redwood as the SUP.

**Note:**

The Clearwater SUP is built the same way traditional wood strip surfboards, canoes, and kayaks are built. If something isn't clear email us at [info@woodsufboardsupply.com](mailto:info@woodsufboardsupply.com) and we'll get you an answer.



## APPENDIX K - LINKS

The links on this page are provided for your convenience.

### Materials and Kits:

<http://www.fiberglasssupply.com> - Resin, glass, blanks, fins, and more

<http://surfinggreen.com.au> - Australian dealer that carries everything from kits to wood

<http://www.greenlightsurfsupply.com> - Resin, tools, eco friendly glassing supplies

<http://www.uscomposites.com> - Resin, glass and lots more

<http://www.fiberglasswarehouse.com> - Resin, glass, and everything else

<http://www.foamez.com> - Blanks, glass, resin, glassing kits, information

<http://www.hobbylinc.com/prods/rgc.htm> - Instant glue and accelerator

### Tools and Supplies:

<http://www.grizzly.com> - Every kind of woodworking equipment, tools and supplies you could need.

<http://www.austinhardwoods.com> - California based supplier of kits, wood, tools.

<http://www.goosebaylumber.com.com> - New Hampshire based wood and kit supplier

### Information:

<http://www.surfingvancoverisland.com/surf/shapers.htm> - Tons of Information and Links

<http://surfcoachbook.com/intro.html> - Shaping, Glassing, and Repairing Dings

<http://www.surfboardsinteractive.com> - Surfboard Shaping Tool

[http://www.expertvillage.com/video-series/3734\\_make-surfboard.htm](http://www.expertvillage.com/video-series/3734_make-surfboard.htm) - Lots of good tips

[http://www.swaylocks.com/resources/detail\\_page.cgi?ID=440](http://www.swaylocks.com/resources/detail_page.cgi?ID=440) - Tips collected from Swaylocks

<http://www.isurfing.com/index.html> - Hundreds of good links

<http://www.surfersteve.com/introduction.htm> - Mostly about foamies but lots of good information

### Builders Forums:

<http://www.grainsurf.com/forum> - Many builders making WSS kits. Go to the Projects area.

<http://www.swaylocks.com> - The original for all kinds of surfboards

<http://www.surfboardbuilding.com> - Anthony's Board Building Links

<http://www.woodworkforums.ubeaut.com.au/index.php> - Aussie builders forum

### Inspiration:

<http://hollowbalsa.com>

<http://woods surfboardplans.com>

<http://www.timberlinesurf.com>

<http://www.florasurfboards.blogspot.com>

<http://www.chuckbassett.com>

Search [www.youtube.com](http://www.youtube.com) for videos on surfboard glassing, shaping, fins, wood surfboards, anything you can think of. You'll be amazed what's available.

Check [www.woods surfboardsupply.com](http://www.woods surfboardsupply.com) often. New shapes and products are being added all the time.