

Grizzly **Industrial, Inc.**®

MODEL T25942 **PRO SANDING ROLLER**

OWNER'S MANUAL *(For models manufactured since 04/16)*



COPYRIGHT © MAY, 2016 BY GRIZZLY INDUSTRIAL, INC.
**WARNING: NO PORTION OF THIS MANUAL MAY BE REPRODUCED IN ANY SHAPE
OR FORM WITHOUT THE WRITTEN APPROVAL OF GRIZZLY INDUSTRIAL, INC.**
#WK18140 PRINTED IN CHINA



WARNING!

This manual provides critical safety instructions on the proper setup, operation, maintenance, and service of this machine/tool. Save this document, refer to it often, and use it to instruct other operators.

Failure to read, understand and follow the instructions in this manual may result in fire or serious personal injury—including amputation, electrocution, or death.

The owner of this machine/tool is solely responsible for its safe use. This responsibility includes but is not limited to proper installation in a safe environment, personnel training and usage authorization, proper inspection and maintenance, manual availability and comprehension, application of safety devices, cutting/sanding/grinding tool integrity, and the usage of personal protective equipment.

The manufacturer will not be held liable for injury or property damage from negligence, improper training, machine modifications or misuse.



WARNING!

Some dust created by power sanding, sawing, grinding, drilling, and other construction activities contains chemicals known to the State of California to cause cancer, birth defects or other reproductive harm. Some examples of these chemicals are:

- Lead from lead-based paints.
- Crystalline silica from bricks, cement and other masonry products.
- Arsenic and chromium from chemically-treated lumber.

Your risk from these exposures varies, depending on how often you do this type of work. To reduce your exposure to these chemicals: Work in a well ventilated area, and work with approved safety equipment, such as those dust masks that are specially designed to filter out microscopic particles.

SECTION 1: SAFETY

WARNING

For Your Own Safety Read Instruction Manual Before Operating This Power Tool

The purpose of safety symbols is to attract your attention to possible hazardous conditions. This manual uses a series of symbols and signal words which are intended to convey the level of importance of the safety messages. The progression of symbols is described below. Remember that safety messages by themselves do not eliminate danger and are not a substitute for proper accident prevention measures.

DANGER

Indicates an imminent hazardous situation which, if not avoided, **WILL** result in death or serious injury.

WARNING

Indicates a potentially hazardous situation which, if not avoided, **COULD** result in death or serious injury.

CAUTION

Indicates a potentially hazardous situation which, if not avoided, **MAY** result in minor or moderate injury. It may also be used to alert against unsafe practices.

NOTICE

This symbol is used to alert the user to useful information about proper operation of the equipment.

WARNING

Safety Instructions for Power Tools

OWNER'S MANUAL. Read and understand this owner's manual **BEFORE** using machine.

TRAINED OPERATORS ONLY. Untrained operators have a higher risk of being hurt or killed. Only allow trained/supervised people to use this power tool. When tool is not being used, disconnect power, and store in out-of-reach location to prevent unauthorized use—especially around children. Make workshop kid proof!

DANGEROUS ENVIRONMENTS. Do not use tools in areas that are wet, cluttered, or have poor lighting. Operating tools in these areas greatly increases risk of accidents and injury.

MENTAL ALERTNESS REQUIRED. Full mental alertness is required for safe operation of power tools. Never operate under the influence of drugs or alcohol, when tired, or when distracted.

DISCONNECT POWER FIRST. Always disconnect tool from power supply **BEFORE** making adjustments, changing tooling, or servicing machine. This prevents an injury risk from unintended startup or contact with live electrical components.

EYE PROTECTION. Always wear ANSI-approved safety glasses or a face shield when operating or observing machinery to reduce the risk of eye injury or blindness from flying particles. Everyday eyeglasses are not approved safety glasses.

WARNING

ELECTRICAL SAFETY. Tool plug must match outlet. Double-insulated tools have a polarized plug (one blade is wider than the other), which must be plugged into a polarized outlet. Never modify plug. Do not use adapter for grounded tools. Use a ground fault circuit interrupter if operation is unavoidable in damp locations. Avoid touching grounded surfaces when operating tool.

WEARING PROPER APPAREL. Do not wear clothing, apparel or jewelry that can become entangled in moving parts. Always tie back or cover long hair. Wear non-slip footwear to avoid accidental slips, which could cause loss of workpiece control. Wear hard hat as needed.

HAZARDOUS DUST. Dust created while using tools may cause cancer, birth defects, or long-term respiratory damage. Be aware of dust hazards associated with each workpiece material, always wear a NIOSH-approved respirator, and connect tool to an appropriate dust collection device to reduce your risk.

HEARING PROTECTION. Always wear hearing protection when operating or observing loud machinery. Extended exposure to this noise without hearing protection can cause permanent hearing loss.

REMOVE ADJUSTING TOOLS. Never leave adjustment tools, chuck keys, wrenches, etc. in or on tool—especially near moving parts. Verify removal before starting!

INTENDED USAGE. Only use tool for its intended purpose. Never modify or alter tool for a purpose not intended by the manufacturer or serious injury or death may result!

AWKWARD POSITIONS. Keep proper footing and balance at all times when operating tool. Do not overreach! Avoid awkward hand positions that make tool control difficult or increase the risk of accidental injury.

SAFE HANDLING. Firmly grip tool. To avoid accidental firing, do not keep finger on switch or trigger while carrying.

FORCING TOOLS. Use right tool for job, and do not force it. It will do job safer and better at rate for which it was designed.

SECURING WORKPIECE. When required, use clamps or vises to secure workpiece. This protects hands and frees both of them to operate tool.

GUARDS & COVERS. Guards and covers reduce accidental contact with moving parts or flying debris. Ensure they are properly installed, undamaged, and working correctly.

CHILDREN & BYSTANDERS. Keep children and bystanders at a safe distance from the work area. Stop using tool if they become a distraction.

USE RECOMMENDED ACCESSORIES. Consult this manual or manufacturer for recommended accessories. Using improper accessories will increase risk of serious injury.

MAINTAIN WITH CARE. Keep cutting tool edges sharp and clean. Follow all maintenance instructions and lubrication schedules to keep tool in good working condition. A tool that is improperly maintained could malfunction, leading to serious personal injury or death. Only have tool serviced by qualified service-personnel using matching replacement parts.

CHECK DAMAGED PARTS. Regularly inspect tool for any condition that may affect safe operation. Immediately repair or replace damaged or mis-adjusted parts before operating tool.

MAINTAIN POWER CORDS. When disconnecting cord-connected tools from power, grab and pull the plug—NOT the cord. Carrying or pulling the cord may damage wires inside. Do not handle cord/plug with wet hands. Avoid cord damage by keeping it away from heated surfaces, high traffic areas, harsh chemicals, sharp edges, moving parts, and wet/damp locations. Damaged cords increase risk of electrocution.

UNATTENDED OPERATION. Never leave tool running while unattended. Turn tool **OFF** and ensure all moving parts completely stop before walking away.

EXPERIENCING DIFFICULTIES. If at any time you experience difficulties performing the intended operation, stop using the machine! Contact our Technical Support at (570) 546-9663.

Additional Safety Instructions for Roll Sanders

WARNING

PROPER ATTACHMENTS. Only use undamaged sanding/grinding/polishing attachments that are rated for the spindle size of this tool and designed for the intended use. Attachments that do not properly fit on spindle could fly apart or come loose from tool during use and strike you, causing serious injury or blindness.

ATTACHMENT SPEED RATING.

Attachments operated at a faster speed than rated for may break or fly apart and strike you with great force. Before mounting a new attachment, be sure the RPM rating is equal to or higher than the speed of this tool.

AVOIDING FIRE HAZARD. Do not use near flammable/combustible materials. Avoid overheating workpiece or sander to reduce fire hazard.

CONTROLLING TOOL. Always use both hands and maintain a firm grip on tool during operations to prevent kickback and avoid kickback-related injuries. Pay special attention when working corners and edges, as these operations have greater tendency to produce kickback/loss of control.

TRANSPORTING TOOL. Always turn tool **OFF** and disconnect it from power while carrying tool at your side. Otherwise, accidental startup of tool could cause spinning attachment to snag clothing, pulling tool toward your body, causing injury.

HAND/ATTACHMENT CONTACT.

Spinning attachments have the capability of removing a lot of skin fast. Keep a firm grip on the tool and position your hands at a safe distance from attachment during operation. Avoid wearing gloves, as they may get caught in spinning attachment and cause even more serious entanglement injuries.

COMPLETING OPERATION. Always wait for tool to come to a complete stop before setting it down. Otherwise, spinning attachment may grab surface or other object and pull tool out of your control, causing personal injury or property damage.

TOOL VENTILATION. Inspect and clean tool air vent on a regular basis. Failure to do so can cause overheating of motor, tool failure, and electrical hazards.

SECTION 2: INTRODUCTION

Foreword

We are proud to offer this manual with your new Model T25942 Pro Sanding Roller! We've made every effort to be exact with the instructions, specifications, drawings, and photographs of the T25942 we used when writing this manual. However, sometimes we still make an occasional mistake.

Also, owing to our policy of continuous improvement, your Sanding Roller may not exactly match the one shown in the manual. If you find this to be the case, and the difference between the manual and your item leaves you in doubt, check our website for the latest manual update or call technical support for help.

For your convenience, we post all available manuals and manual updates for free on our website at www.grizzly.com. Any updates to your model of tool will be reflected in these documents as soon as they are complete.

Contact Info

We stand behind our tools. If you have any service questions, parts requests or general questions about the product, please call or write us at the location listed below.

Grizzly Technical Support
1815 W. Battlefield
Springfield, MO 65807
Phone: (570) 546-9663
Email: techsupport@grizzly.com

We want your feedback on this manual. What did you like about it? Where could it be improved? Please take a few minutes to give us feedback.

Grizzly Industrial, Inc.
C/O Technical Documentation Manager
P.O. Box 2069
Bellingham, WA 98227-2069
Email: manuals@grizzly.com

Specifications

Weight	4 lbs.
Length x Width x Height20 x 5½ x 3 in.
Horsepower	300W (0.4 HP)
Voltage	120V
Phase	Single-Phase
Amps	2.5A
Speed	Variable, 1600–3300 RPM
Spindle Diameter	12mm
Spindle Length	63mm
Number of Dust Ports	1
Dust Port Size	1 in.

SECTION 3: SETUP

Unpacking

Your tool was carefully packaged for safe transportation. Remove the packaging materials from around your tool and inspect it. If you discover the tool is damaged, *please immediately call Customer Service at (570) 546-9663 for advice.*

Save the containers and all packing materials for possible inspection by the carrier or its agent. Otherwise, filing a freight claim can be difficult.

When you are completely satisfied with the condition of your shipment, inventory the contents.

If any non-proprietary parts are missing (e.g., a nut or a washer), we will gladly replace them; or for the sake of expediency, replacements can be obtained at your local hardware store.

WARNING

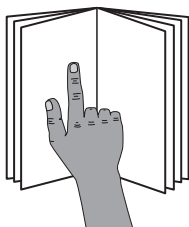

This tool presents serious injury hazards to untrained users. Read through this entire manual to become familiar with the controls and operations before starting the tool!

Inventory

Model T25942 Inventory (Figure 1)

- A. Carrying Case..... 1
- B. Pro Sand Roller Tool..... 1
- C. Hex Wrench 4mm..... 1
- D. 80-Grit Flap Wheel, 2 $\frac{5}{16}$ " x $\frac{7}{16}$ "..... 1
- E. 80-Grit Flap Wheel, 2 $\frac{5}{16}$ " x 2 $\frac{3}{8}$ "..... 1
- F. Sanding Drum with
80-Grit Sanding Sleeve, 1 $\frac{3}{4}$ " x 2 $\frac{3}{8}$ ".. 1



Figure 1. Model T25942 inventory.

Test Run

Before installing attachments and using your Model T25942, test run the tool to make sure it runs properly.

If, during the test run, you cannot easily locate the source of an unusual noise or vibration, stop using the tool immediately, then review the **Troubleshooting** guide on **Page 14**.

If you still cannot remedy a problem, contact our Tech Support at (570) 546-9663 for assistance.

To test run tool:

1. Read all safety instructions at beginning of manual.
2. Make sure switch is in OFF position.
3. Connect tool to power source.
4. Hold tool firmly with both hands with one thumb resting on ON/OFF switch.
5. Use your thumb to move switch lock sideways to unlock ON/OFF switch, then push ON/OFF switch forward to turn tool **ON** (see **Figure 2**). Keep your hand poised over switch in case you need to quickly turn tool **OFF**.
6. With tool running, carefully move speed control dial (see **Figure 2**) from "1" to "6", and then back down to "1".
7. Listen and watch for abnormal noises or actions.
 - Investigate strange or unusual noises and correct them before operating tool. Always switch tool **OFF** and disconnect it from power before investigating or correcting problems.
8. Turn tool **OFF**.
9. Attempt to move ON/OFF switch forward without first sliding switch lock sideways.
 - If the tool *does not* start, the switch locking feature is working.
 - If the tool *does* start, switch it **OFF**. The switch locking feature is not working. This safety feature must work properly before proceeding. Call Tech Support for help.

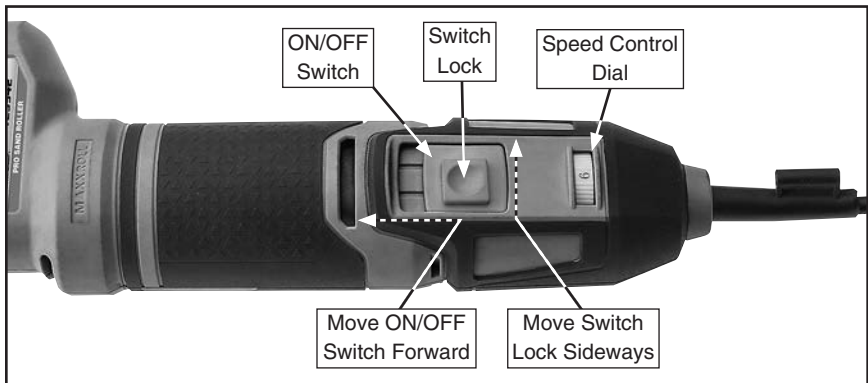

Figure 2. Location of ON/OFF switch and speed control dial.

SECTION 4: OPERATIONS

⚠️ WARNING

Damage to your eyes and lungs could result from using this tool without proper protective gear. Always wear safety glasses and a dust mask/respirator when operating this tool.



⚠️ WARNING

Loose hair and clothing could get caught in tool and cause serious personal injury. Keep loose clothing and long hair away from moving parts.

NOTICE

If you have never used this type of tool or equipment before, WE STRONGLY RECOMMEND that you read books, trade magazines, or get formal training before beginning any projects. Regardless of the content in this section, Grizzly Industrial will not be held liable for accidents caused by lack of training.

Tool Operation Tips

In addition to the safety instructions in this manual, the most important safety consideration is to use common sense at all times. What may be okay in one situation may not be safe in another.

Here are some tips to keep in mind while using this tool:

- Always be sure the attachment is secured on the spindle by tightening the spindle flange screw.
- Always keep one thumb poised over the ON/OFF switch during operations, in case you need to quickly turn tool **OFF**.
- Work against the direction of spindle rotation to maintain optimum control of tool. Working in the same direction as the rotation can cause the tool to lunge or fly out of your hands.
- Concentrate on the task at hand. STOP operations if other people are distracting you or your mind is on something else.

Removing/Installing Attachments

The Model T25942 Pro Sanding Roller comes with three sanding attachments: a 2 $\frac{5}{16}$ " x $\frac{7}{16}$ " 80-Grit flap wheel, a 2 $\frac{5}{16}$ " x 2 $\frac{3}{8}$ " 80-Grit flap wheel, and a sanding drum with a 1 $\frac{3}{4}$ " x 2 $\frac{3}{8}$ " 80-Grit sanding sleeve.

Flap wheels are composed of many sanding flaps that can follow the contours of a workpiece. They are well suited for light sanding and can achieve a more "feathered" result. Examples:

- Sanding thin layers of paint
- Sanding radiused edges and corners
- Light, touch-up sanding

Sanding drums with sleeves are rigid and less "forgiving." They are well suited for aggressive sanding and produce a more precise, defined edge. Examples:

- Sanding paint/glue build-up
- Sanding sharp edges and corners
- Aggressive, rough sanding

CAUTION

Do not make adjustments to tool while it is connected to power. Turn tool **OFF** and disconnect it from power before attempting to install, remove, or adjust any components.

Tool Needed:

Hex Wrench 4mm..... 1

To remove/install attachment:

1. DISCONNECT TOOL FROM POWER!
2. Press spindle lock button to prevent spindle rotation during next step (see **Figure 3**).
3. Remove spindle flange screw (see **Figure 3**), and remove attachment.
4. Slide replacement attachment onto spindle (see **Figure 3**).
5. Thread spindle flange screw into end of spindle, then press spindle lock button as you fully tighten screw (see **Figure 3**).

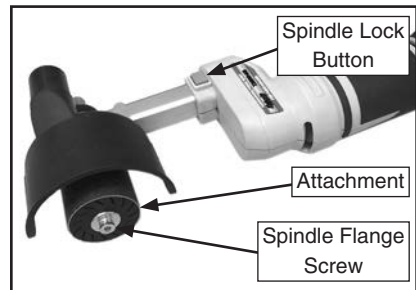

Figure 3. Attachment installation/removal components.

Positioning Dust Shroud

The Model T25942 Pro Sanding Roller is equipped with a dust shroud (see **Figure 4**) that can be positioned according to the needs of the operation.

To adjust the position of the dust shroud, loosen the dust shroud adjustment knob, rotate the dust shroud to the desired position, then re-tighten the knob (see **Figures 4–5**).

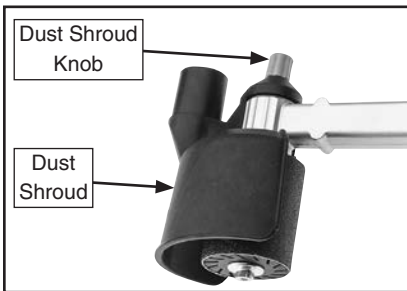

Figure 4. Location of dust shroud adjustment components.



Figure 5. Dust shroud rotated to new position.

Using Dust Collection

The dust shroud is equipped with a 1" dust port that can be connected to a shop vacuum or other dust collection system for added respiratory safety.

To connect your tool to a dust collection system, your system must be equipped with 1" fittings, or alternatively, you can use a length of 1" hose and an adapter, such as Model W1039 Universal Adapter (see **Accessories** on **Page 11**).

Connect the 1" dust collection hose to the dust port of your tool (see **Figure 6**), then connect the other end of the hose to your shop vacuum or dust collector, using the appropriate reducers/adapters, if necessary.

Note: Always secure hoses with hose clamps.

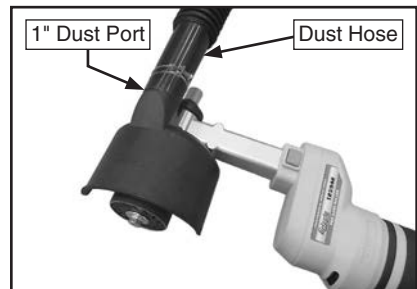

Figure 6. Dust hose connected to 1" dust port.

To use a dust collection system during operation, first turn your dust collection system **ON**, then turn your tool **ON**, and begin operation.

When you are finished with your operation, turn your tool **OFF**, then turn your dust collection system **OFF**.

Operating Tool

Read and follow all of the preceding **Safety** and **Operations** instructions before using your tool.

To operate tool:

1. Secure workpiece, if necessary, to prevent it from moving or shifting during operations.
2. Make sure ON/OFF switch (see **Figure 7**) is in OFF position, to prevent accidental startup, then connect tool to power.
3. Use speed control dial (see **Figure 7**) to select appropriate speed for operation. The dial is marked "1-6," which corresponds to the following speeds:
 - 1-2 Low
 - 3-4 Medium
 - 5-6 High
4. Use your thumb to move switch lock sideways to unlock ON/OFF switch, then push ON/OFF switch forward to turn tool **ON** (see **Figure 7**). Make sure your hand stays poised over switch in case you need to quickly turn tool **OFF**.
5. When finished with operation, turn tool **OFF**, and disconnect it from power.

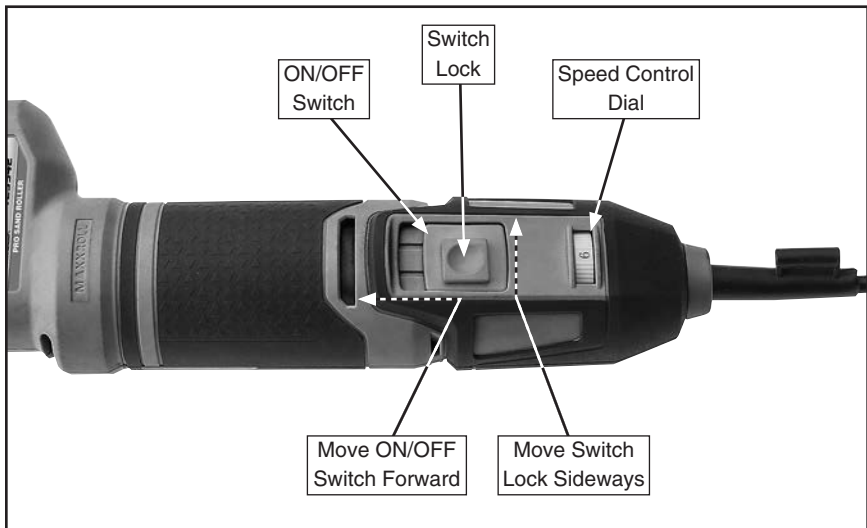

Figure 7. Tool controls.

SECTION 6: ACCESSORIES

W1039—Universal Adapter

This adapter provides a multitude of reducing options. Simply cut off unneeded steps. Outside diameter sizes include 1", 2", 2.5", 3", 4", 5", and 6". Wall thickness is 1/8".



Figure 8. W1039 Universal Adapter.

T27117—Turbo II HEPA Dust Extractor

This powerful wet and dry dust extractor is equipped with tool-coupling, for automatic suction every time you turn your tool on. The high performance turbine provides a 151 cfm (71 l/s) flow rate and 98.4" of water lift (245 mbar vacuum) yet with a quiet volume of 66 dB.



Figure 9. T27117 Turbo II HEPA Dust Extractor.

Basic Eye Protection

T20501—Face Shield Protector 4"

T20502—Face Shield Protector 7"

T20503—Face Shield Window

T20451—Clear Safety Glasses

T20452—Anti-Reflective S. Glasses

H7194—Bifocal Safety Glasses 1.5

H7195—Bifocal Safety Glasses 2.0

H7196—Bifocal Safety Glasses 2.5

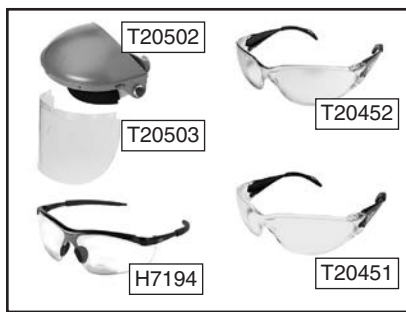

Figure 10. Basic eye protection.

H2499—Small Half-Mask Respirator

H3631—Medium Half-Mask Respirator

H3632—Large Half-Mask Respirator

H3635—Cartridge Filter Pair P100

If you work around dust everyday, a half-mask respirator can be a lifesaver. Also compatible with safety glasses!



Figure 11. Half-mask respirator with disposable cartridge filters.

order online at www.grizzly.com or call 1-800-523-4777

SECTION 7: MAINTENANCE

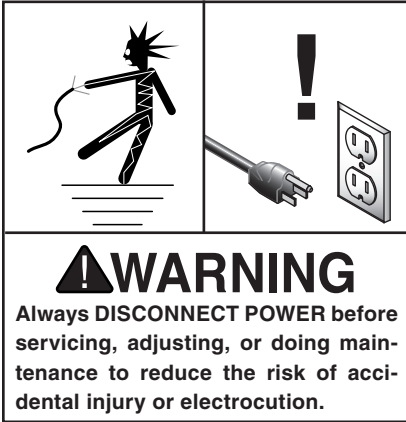

For optimum performance, routinely check the condition of the following items and repair or replace them as necessary:

- Worn sanding sleeve/attachment.
- Clogged/dirty motor vent.
- Loose components/attachments.
- Worn switch.
- Worn or damaged cords and plugs.
- Any other condition that could hamper the safe operation of this tool.

Cleaning Motor Vent

The motor vent (see **Figure 12**) provides ventilation to the motor and helps to prevent it from overheating. After prolonged use, the vent may become dirty and clogged, and require cleaning.

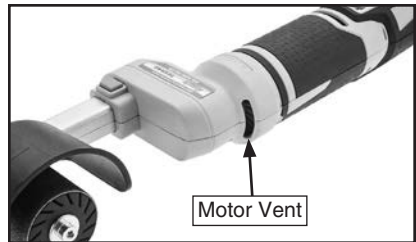

Figure 12. Location of motor vent.

To clean the vent, use a shop vacuum to vacuum out the opening.

Removing/Replacing Sanding Sleeve

The sanding sleeve can be removed from the sanding drum and replaced with a new sleeve according to the needs of your operation.

Tool Needed:

Hex Wrench 4mm..... 1

To remove sanding sleeve:

1. DISCONNECT TOOL FROM POWER!
2. Remove dust shroud knob, then remove dust shroud (see **Figure 13**).

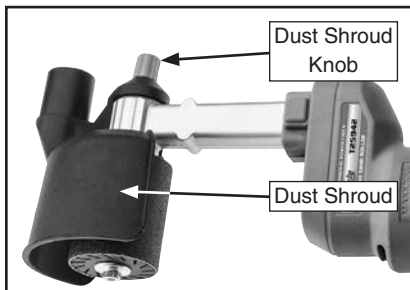

Figure 13. Location of dust shroud and dust shroud knob.

3. Press spindle lock button to prevent spindle rotation during following steps (see **Figure 14**).

Note: *If spindle does not lock right away, rotate it while pressing spindle lock button until button engages with spindle and locks it.*

4. With spindle locked, rotate sanding sleeve in direction of slits in sanding drum, while simultaneously pulling sleeve off of drum (see **Figure 14**).

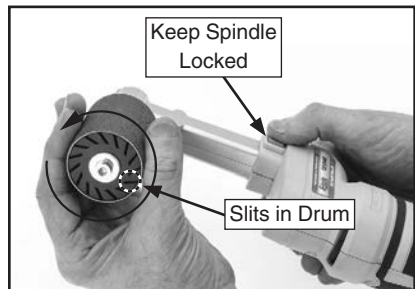

Figure 14. Removing sanding sleeve.

5. With spindle still locked, slide a new sanding sleeve onto sanding drum, while simultaneously rotating sleeve in direction of slits.
6. Re-install dust shroud and secure it with dust shroud knob.

SECTION 8: SERVICE

Review the troubleshooting and procedures in this section if a problem develops with your tool. If you need replacement parts or additional help with a procedure, call our Technical Support.

Troubleshooting

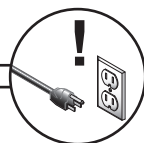

Motor & Electrical

Symptom	Possible Cause	Solution
Tool will not start; fuses or circuit breakers blow.	<ol style="list-style-type: none"> 1. Wall circuit breaker tripped. 2. Plug/receptacle at fault. 3. Switch lock engaged. 4. ON/OFF switch at fault. 5. Wiring open/has high resistance. 6. Short circuit in motor or loose connections. 7. Motor at fault. 	<ol style="list-style-type: none"> 1. Ensure circuit size is correct; reset/replace breaker. 2. Test for good contacts; correct the wiring. 3. Slide switch sideways to unlock switch (Page 10) or replace switch. 4. Test/replace switch. 5. Check/fix broken, disconnected, or corroded wires. 6. Inspect connections on motor for loose or shorted terminals or worn insulation. 7. Test/repair/replace.
Tool slows/stops.	<ol style="list-style-type: none"> 1. Motor overloaded. 2. Short circuit in motor or loose connections. 	<ol style="list-style-type: none"> 1. Clean motor, let cool, and reduce load on motor. 2. Inspect connections on motor for loose or shorted terminals or worn insulation.
Tool has vibration or noisy operation.	<ol style="list-style-type: none"> 1. Sanding attachment not properly installed. 2. Dust shroud is loose. 3. Sanding sleeve is worn/frayed and slipping on drum or slapping dust shroud. 	<ol style="list-style-type: none"> 1. Properly install sanding attachment and tighten flange screw (Page 8). 2. Tighten dust shroud (Page 9). 3. Replace sanding sleeve (Page 13).

Symptom	Possible Cause	Solution
Sanding grains easily rub off sleeve or flap wheel.	<ol style="list-style-type: none"> 1. Sanding sleeve/flap wheel has been stored in an incorrect environment. 2. Sanding sleeve/flap wheel has been crushed or bent. 	<ol style="list-style-type: none"> 1. Store sanding sleeve/flap wheel in a cool, dry area; replace. 2. Prevent sanding sleeve/flap wheel from being crushed or bent; replace.
Deep sanding grooves or scars in workpiece.	<ol style="list-style-type: none"> 1. Sanding sleeve/flap wheel too coarse for desired finish. 2. Workpiece sanded across the grain. 3. Too much sanding force on workpiece. 4. Tool held still for too long while sanding. 	<ol style="list-style-type: none"> 1. Use finer grit sanding sleeve/flap wheel. 2. Sand with grain. 3. Reduce pressure on workpiece while sanding. 4. Keep tool moving while sanding.
Sanding sleeve/flap wheel clogs quickly.	<ol style="list-style-type: none"> 1. Too much sanding force on workpiece. 2. Sanding softwood. 3. Sanding sleeve/flap wheel worn or damaged. 	<ol style="list-style-type: none"> 1. Clean sanding sleeve/flap wheel, and then reduce pressure on workpiece while sanding. 2. Use different stock, or accept characteristics of stock and plan to clean/replace sanding sleeve/flap wheel frequently. 3. Replace sanding sleeve (Page 13)/flap wheel (Page 8).
Glazed sanding surface.	<ol style="list-style-type: none"> 1. Sanding wet stock. 2. Sanding stock with high amount of residue. 3. Sanding sleeve/flap wheel clogged or worn. 	<ol style="list-style-type: none"> 1. Only sand stock with moisture content below 20%. 2. Use different stock, or accept characteristics of stock and plan to clean/replace sanding sleeve/flap wheel frequently. 3. Clean/replace sanding sleeve/flap wheel.
Burn marks on workpiece.	<ol style="list-style-type: none"> 1. Sanding grit too fine. 2. Using too much pressure. 3. Tool held still for too long while sanding. 4. Sanding sleeve/flap wheel clogged or worn. 	<ol style="list-style-type: none"> 1. Use coarser grit sanding sleeve/flap wheel. 2. Reduce pressure on workpiece while sanding. 3. Keep tool moving while sanding. 4. Clean/replace sanding sleeve/flap wheel.

Carbon Brushes

The Model T25942 is equipped with a pair of carbon brushes that are NOT designed to be user-serviceable or replaceable. The brushes shown in the parts breakdown are for reference purposes only and are NOT available for purchase.

As with all similarly constructed tools, the carbon brushes are considered to be a regular "wear" item. In other words, they will eventually wear out and will do so in direct proportion to overall tool use (or abuse). As such, brush wear is NOT covered under warranty. However, when used with care, this tool will provide an extended level of service and brush wear will be relatively slow.

SECTION 9: PARTS

We do our best to stock replacement parts when possible, but we cannot guarantee that all parts shown are available for purchase. Call **(800) 523-4777** or visit www.grizzly.com/parts to check for availability.

Main

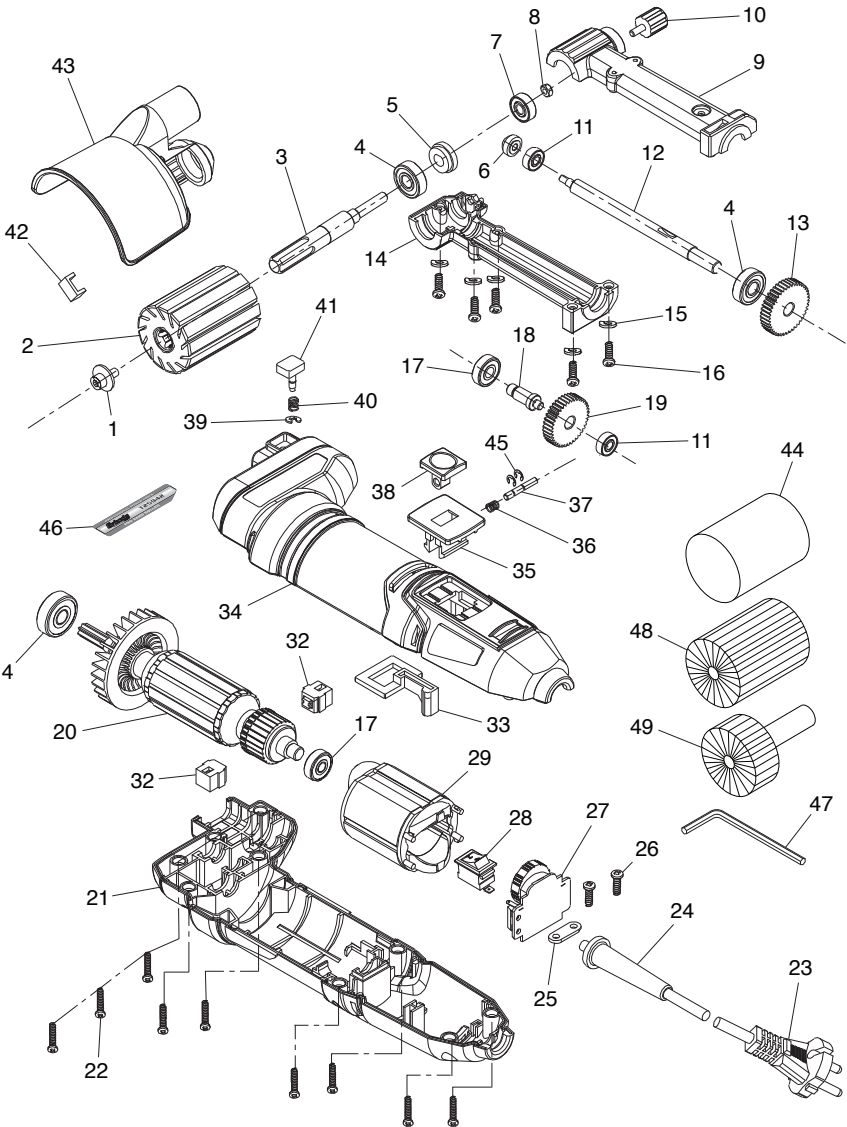

Main Parts List

REF	PART #	DESCRIPTION
1	PT25942001	SPINDLE FLANGE SCREW M5-.8 X 10
2	PT25942002	SANDING DRUM 1-3/4 X 2-3/8"
3	PT25942003	SPINDLE
4	PT25942004	BALL BEARING 608ZZ
5	PT25942005	GEAR 18T
6	PT25942006	GEAR 11T
7	PT25942007	BALL BEARING 606ZZ
8	PT25942008	HEX NUT M4-.7
9	PT25942009	LOWER SHAFT HOUSING (ALUMINUM)
10	PT25942010	KNOB BOLT M4-.7 X 8, 14D X 15L
11	PT25942011	BALL BEARING 605ZZ
12	PT25942012	TRANSMISSION SHAFT (LONG)
13	PT25942013	GEAR 42T
14	PT25942014	UPPER SHAFT HOUSING (ALUMINUM)
15	PT25942015	LOCK WASHER 3MM
16	PT25942016	PHLP HD SCR M3-.5 X 10
17	PT25942017	BALL BEARING 607ZZ
18	PT25942018	TRANSMISSION SHAFT (SHORT)
19	PT25942019	GEAR 39T
20	PT25942020	ROTOR
21	PT25942021	HOUSING (UPPER)
22	PT25942022	TAP SCREW M4 X 16
23	PT25942023	POWER CORD 18G 2W 72" 5-15P
24	PT25942024	CABLE SLEEVE
25	PT25942025	CABLE CLAMP
26	PT25942026	TAP SCREW M4 X 12
27	PT25942027	CIRCUIT BOARD
28	PT25942028	ROCKER SWITCH GREE KCD1 10A 125V
29	PT25942029	STATOR
32	PT25942032	CARBON BRUSH ASSEMBLY
33	PT25942033	SWITCH CONNECTOR
34	PT25942034	HOUSING (LOWER)
35	PT25942035	SWITCH ACTUATOR
36	PT25942036	COMPRESSION SPRING 0.6 X 6 X 6.8
37	PT25942037	SWITCH PIN 3 X 20
38	PT25942038	SWITCH LOCK
39	PT25942039	E-CLIP 4MM
40	PT25942040	COMPRESSION SPRING 0.5 X 8.3 X 9.5
41	PT25942041	SPINDLE LOCK BUTTON
42	PT25942042	U-SHAPE CERAMIC PLATE
43	PT25942043	DUST SHROUD W/1" PORT
44	PT25942044	SANDING SLEEVE 1-3/4 X 2-3/8", 80-GRIT
45	PT25942045	E-CLIP 3MM
46	PT25942046	MACHINE ID LABEL
47	PT25942047	HEX WRENCH 4MM
48	PT25942048	FLAP WHEEL 2-5/16" X 2-3/8", 80-GRIT
49	PT25942049	FLAP WHEEL 2-5/16" X 7/16", 80-GRIT



WARRANTY CARD

Name _____

Street _____

City _____ State _____ Zip _____

Phone # _____ Email _____ Invoice # _____

Model # _____ Order # _____ Serial # _____

*The following information is given on a voluntary basis. It will be used for marketing purposes to help us develop better products and services. **All information is strictly confidential.***

1. How did you learn about us?

Advertisement Friend Catalog
 Card Deck Website Other: _____

2. Which of the following magazines do you subscribe to?

Cabinet Maker Popular Mechanics Today's Homeowner
 Family Handyman Popular Science Wood
 Hand Loader Popular Woodworking Wooden Boat
 Handy Practical Homeowner Woodshop News
 Home Shop Machinist Precision Shooter Woodsmith
 Journal of Light Cont. Projects in Metal Woodwork
 Live Steam RC Modeler Woodworker West
 Model Airplane News Rifle Woodworker's Journal
 Modeltec Shop Notes Other:
 Old House Journal Shotgun News

3. What is your annual household income?

\$20,000-\$29,000 \$30,000-\$39,000 \$40,000-\$49,000
 \$50,000-\$59,000 \$60,000-\$69,000 \$70,000+

4. What is your age group?

20-29 30-39 40-49
 50-59 60-69 70+

5. How long have you been a woodworker/metalworker?

0-2 Years 2-8 Years 8-20 Years 20+ Years

6. How many of your machines or tools are Grizzly?

0-2 3-5 6-9 10+

7. Do you think your machine represents a good value? Yes No

8. Would you recommend Grizzly Industrial to a friend? Yes No

9. Would you allow us to use your name as a reference for our customers in your area?

Note: *We never use names more than 3 times.* Yes No

10. Comments: _____

Send a Grizzly Catalog to a friend:

Name _____
Street _____
City _____ State _____ Zip _____

FOLD ALONG DOTTED LINE

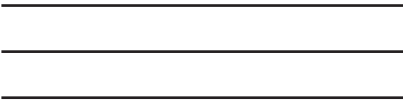

Place
Stamp
Here



GRIZZLY INDUSTRIAL, INC.
P.O. BOX 2069
BELLINGHAM, WA 98227-2069



TAPE ALONG EDGES--PLEASE DO NOT STAPLE

WARRANTY

Grizzly Industrial, Inc. warrants every product it sells for a period of **1 year** to the original purchaser from the date of purchase. This warranty does not apply to defects due directly or indirectly to misuse, abuse, negligence, accidents, repairs or alterations or lack of maintenance. This is Grizzly's sole written warranty and any and all warranties that may be implied by law, including any merchantability or fitness, for any particular purpose, are hereby limited to the duration of this written warranty. We do not warrant or represent that the merchandise complies with the provisions of any law or acts unless the manufacturer so warrants. In no event shall Grizzly's liability under this warranty exceed the purchase price paid for the product and any legal actions brought against Grizzly shall be tried in the State of Washington, County of Whatcom.

We shall in no event be liable for death, injuries to persons or property or for incidental, contingent, special, or consequential damages arising from the use of our products.

To take advantage of this warranty, contact us by mail or phone and give us all the details. We will then issue you a "Return Number," which must be clearly posted on the outside as well as the inside of the carton. We will not accept any item back without this number. Proof of purchase must accompany the merchandise.

The manufacturers reserve the right to change specifications at any time because they constantly strive to achieve better quality equipment. We make every effort to ensure that our products meet high quality and durability standards and we hope you never need to use this warranty.

Please feel free to write or call us if you have any questions about the machine or the manual.

Thank you again for your business and continued support. We hope to serve you again soon.

Grizzly Tech Support
1815 W. Battlefield
Springfield, MO 65807
Phone: (570) 546-9663

E-Mail:
techsupport@grizzly.com

Web Site: <http://www.grizzly.com>

grizzly.com[®]
TOOL WEBSITE

Buy Direct and Save with Grizzly[®] – Trusted, Proven and a Great Value!
~Since 1983~

*Visit Our Website Today For
Current Specials!*

**ORDER
24 HOURS A DAY!
1-800-523-4777**

